



Scan the QR code to read the manual in other language (FR+IT+PL+ES+PT).



Scan the QR code to read the manual in other language (DE+TR+NL+RO+RU).



Scan the QR code to install the control APP.

# OPERATION MANUAL HYUNDAI

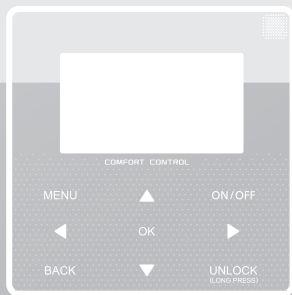

Thank you very much for purchasing our product.  
Before using your unit, please read this manual carefully and keep it for future reference.

- This manual gives detailed description of the precautions that should be brought to your attention during operation.
- In order to ensure correct service of the wired controller, please read this manual carefully before using the unit.
- For convenience of future reference, keep this manual after reading it.

# CONTENTS

---

## 1 GENERAL SAFETY PRECAUTIONS

- 1.1 About the documentation ..... 01
- 1.2 For the user ..... 02

## 2 A GLANCE OF THE USER INTERFACE

- 2.1 The appearance of the wired controller ..... 05
- 2.2 Status icons ..... 06

## 3 USING HOME PAGES

- 3.1 About home pages ..... 07

## **4 MENU STRUCTURE**

- 4.1 About the menu structure ..... 11
- 4.2 To go to the menu structure ..... 11
- 4.3 To navigate in the menu structure ..... 11

## **5 BASIC USAGE**

- 5.1 Screen unlock ..... 12
- 5.2 Turning ON/OFF controls ..... 14
- 5.3 Adjusting the temperature ..... 19
- 5.4 Adjusting space operation mode ..... 22

## **6 NETWORK CONFIGURATION GUIDELINES**

- 6.1 Wired controller setting ..... 25
- 6.2 Mobile device setting ..... 28

## **7 INSTALLATION MANUAL**

- 7.1 Safety precaution ..... 35
- 7.2 Other precautions ..... 38
- 7.3 Installation procedure and matching setting of  
wired controller ..... 39
- 7.4 Front cover installation ..... 46

## **8 MODBUS MAPPING TABLE**

- 8.1 Modbus port communication specification ..... 48

# 1 GENERAL SAFETY PRECAUTIONS

## 1.1 About the documentation

- The original documentation is written in English. All other languages are translations.
- The precautions described in this document cover very important topics, follow them carefully.
- All activities described in the installation manual must be performed by an authorized installer.

### 1.1.1 Meaning of warnings and symbols

#### **DANGER**

Indicates a situation that results in death or serious injury.

---

#### **DANGER: RISK OF ELECTROCUTION**

Indicates a situation that could result in electrocution.

---

#### **DANGER: RISK OF BURNING**

Indicates a situation that could result in burning because of extreme hot or cold temperatures.

 **WARNING**

Indicates a situation that could result in death or serious injury.

---

 **CAUTION**

Indicates a situation that could result in minor or moderate injury.

---

 **NOTE**

Indicates a situation that could result in equipment or property damage.

---

 **INFORMATION**

Indicates useful tips or additional information.

## 1.2 For the user

- If you are not sure how to operate the unit, contact your installer.

- The appliance is not intended for use by persons, including children, with reduced physical, sensory or mental capabilities, or lack of experience and knowledge, unless they have been given supervision or instruction concerning use of the appliance by a person responsible for their safety. Children must be supervised to ensure that they do not play with the product.



## CAUTION

Do NOT rinse the unit. This may cause electric shocks or fire.

---



## NOTE

- Do NOT place any objects or equipment on top of the unit.
- Do NOT sit, climb or stand on the unit.

- Units are marked with the following symbol:



This means that electrical and electronic products may not be mixed with unsorted household waste. Do not try to dismantle the system yourself: the dismantling of the system, treatment of the refrigerant, of oil and of other parts must be done by an authorized installer and must comply with applicable legislation. Units must be treated at a specialized treatment facility for reuse, recycling and recovery. By ensuring this product is disposed of correctly, you will help to prevent potential negative consequences for the environment and human health. For more information, contact your installer or local authority.

## 2 A GLANCE OF THE USER INTERFACE

### 2.1 The appearance of the wired controller

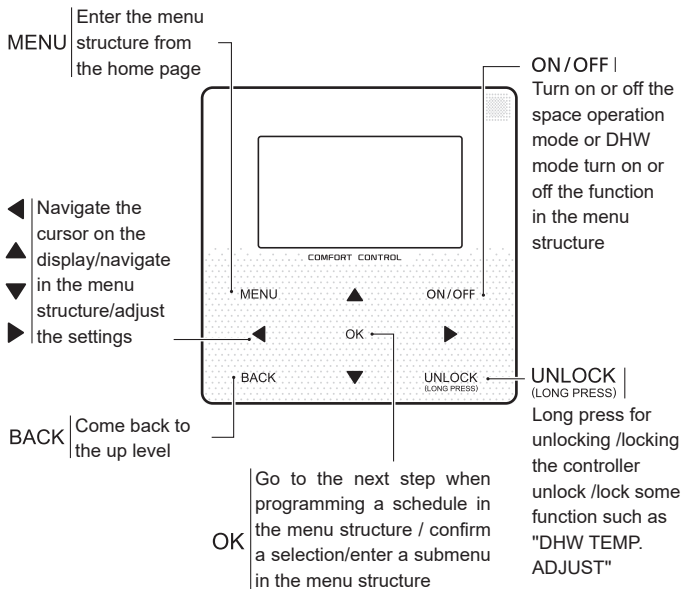

## 2.2 Status icons

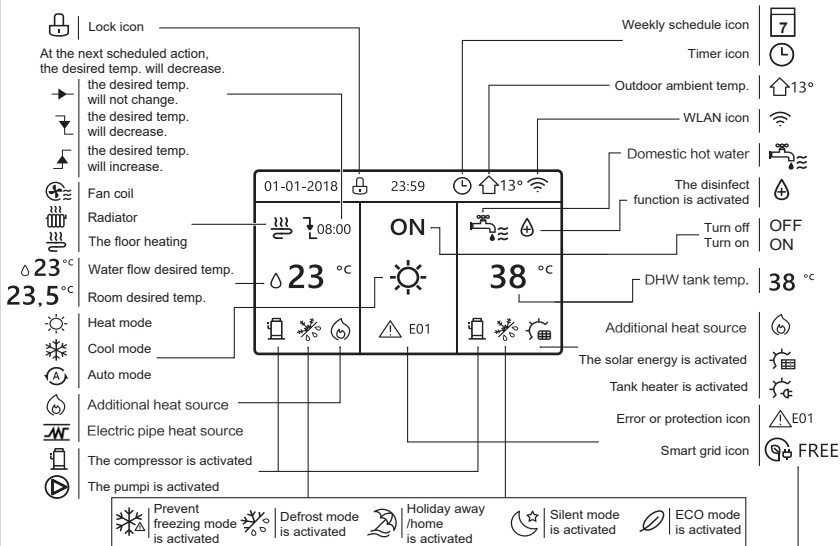

	Fan coil	Radiator	The floor heating	Domestic hot water
ON				
OFF				

	Free electricity	Valley electricity	Peak electricity
Smart grid	FREE	VALLEY	PEAK

## 3 USING HOME PAGES

### 3.1 About home pages

You can use the home pages to read out and change settings that are meant for daily usage. What you can see and do on the home pages is described where applicable. Depending on the system layout, the following home pages may be possible:

- Room desired temperature (ROOM )
- Water flow desired temperature (MAIN)
- DHW tank actual temperature (TANK)

DHW=domestic hot water

home page1 :

If you have set the WATER FLOW TEMP. as YES and ROOM TEMP. as NON, the system has the function including floor heating and making hot water. The following page will appear:

#### NOTE

All the pictures in the manual are used to explain, the actual pages in the screen may have some difference.

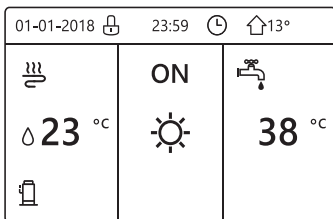







home page2 :

If you have set the WATER FLOW TEMP. as NON and ROOM TEMP. as YES, the system has the function including floor heating and making hot water. The following page will appear:

#### NOTE

The interface should be installed in the floor heating room to check the room temperature.

01-01-2018 	23:59 	 13°
 <b>23.5 °C</b> 	<b>ON</b> 	 <b>38 °C</b>

### home page3 :

If the DHW MODE is set NON , and if "WATER FLOW TEMP." is set YES, "ROOM TEMP." is set YES, There will be main page and additional page. The system has the function including floor heating and space cooling for fan coil, home page 3 will appear:

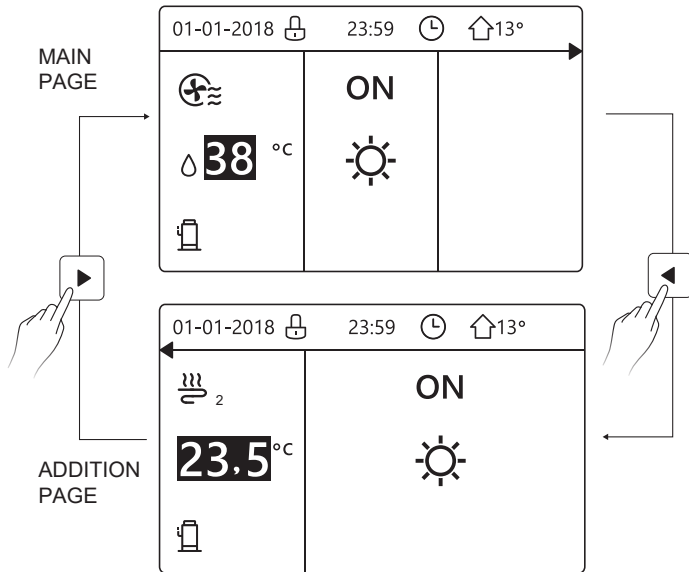

## home page4 :

If the DHW MODE is set YES. There will be main page and addition page. The system has the function including floor heating, space cooling for fan coil and domestic hot water, home page 4 will appear:

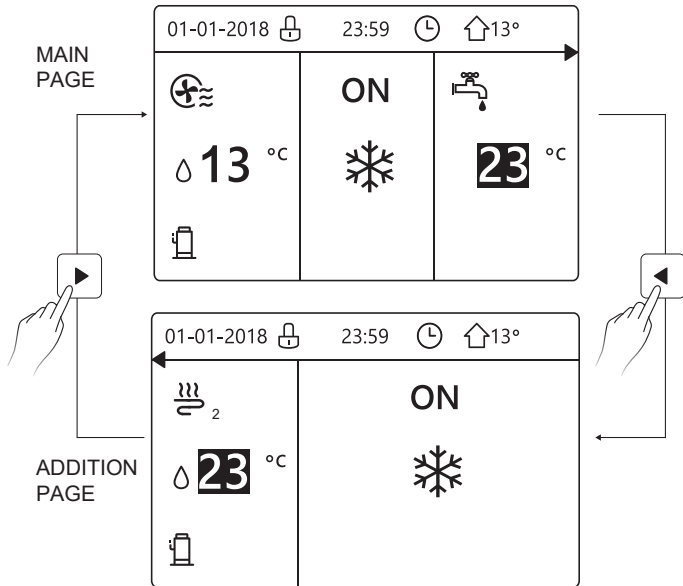

## 4 MENU STRUCTURE

### 4.1 About the menu structure

You can use the menu structure to read out and configure settings that are NOT meant for daily usage. What you can see and do in the menu structure is described where applicable.

### 4.2 To go to the menu structure

From a home page, press "MENU". Result: The menu structure appear:

MENU	1/2
<b>OPERATION MODE</b>	
PRESET TEMPERATURE	
DOMESTIC HOT WATER(DHW)	
SCHEDULE	
OPTIONS	
CHILD LOCK	
<b>OK</b> ENTER	↕

MENU	2/2
<b>SERVICE INFORMATION</b>	
OPERATION PARAMRTER	
FOR SERVICEMAN	
WLAN SETTING	
<b>OK</b> ENTER	↕

### 4.3 To navigate in the menu structure



Use"▼"、"▲" to scroll.

## 5 BASIC USAGE

### 5.1 Screen Unlock

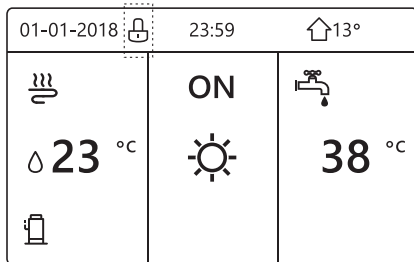
If the icon  is on the screen, the controller is locked. The following page is displayed:



Press any key, the icon  will flash. Long press the "UNLOCK" key. The icon  will disappear, the interface can be controlled.

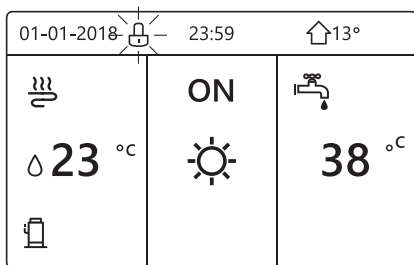

The interface will be locked if there is no handling for a long time (about 120 seconds). If the interface is unlocked, long press "unlock", the interface will be locked.

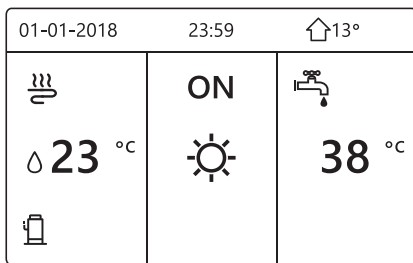

Long press  
UNLOCK



Long press  
UNLOCK

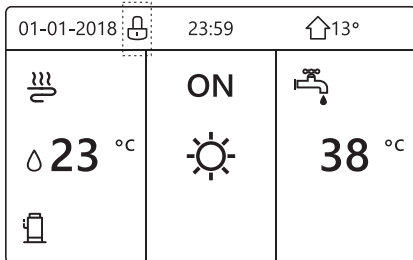



## 5.2 Turning ON/OFF controls

Use the interface to turn on or off the unit for space heating or cooling.

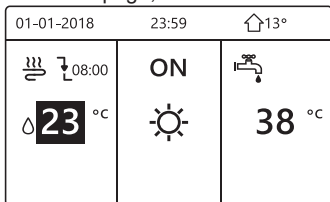
- The ON/OFF of the unit can be controlled by the interface if the ROOM THERMOSTAT is NON. (See "ROOM THERMOSTAT SETTING" in "Installation and owner's manual (M-thermal split indoor unit)")
- Press "◀", "▲" on home page, the black cursor will appear:



1) When the cursor is on the temperature of space operation mode side (Including heat mode , cool mode  and auto mode ) , press "ON/OFF" key to turn on/off space heating or cooling.

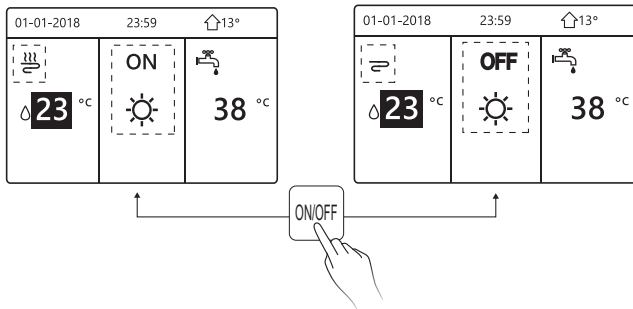

If the DHW TYPE is set NON, then following pages will display:

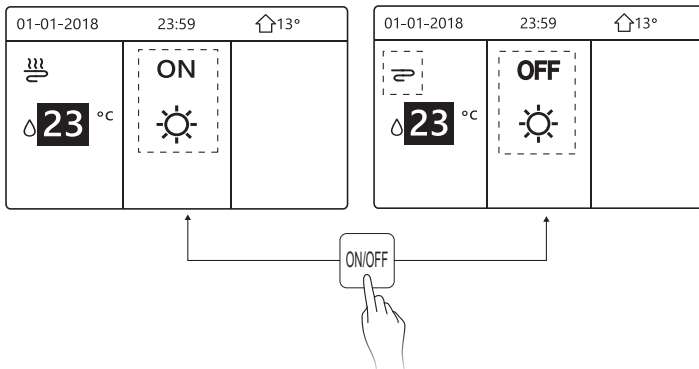

If the TEMP. TYPE is set ROOM TEMP. , then following pages will display:

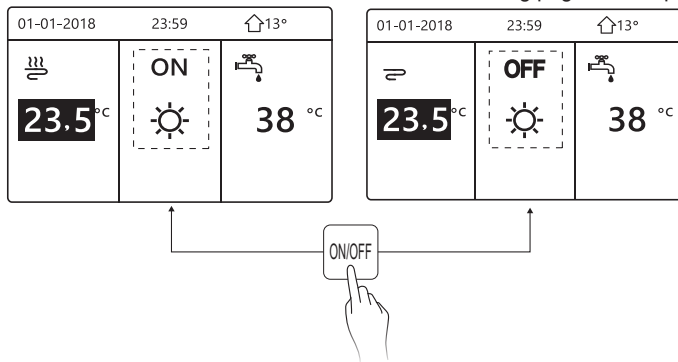

Use the room thermostat to turn on or off the unit for space heating or cooling.

① The room thermostat is SET YES(see "ROOM THERMOSTAT SETTING" on "Installation and owner's manual (M-thermal split indoor unit)") the unit is turned on or off by the room thermostat, press ON/OFF on the interface, the following page will display:

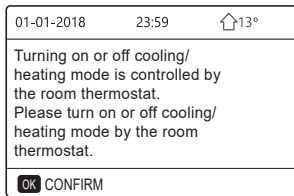

② DUAL ROOM THERMOSTAT is set YES(see "ROOM THERMOSTAT SETTING" in "Installation and owner's manual (M-thermal split indoor unit)"). The room thermostat for fan coil is turned off, the room thermostat for the floor heating is turned on, and the unit is running, but the display is OFF. The following page is displayed:

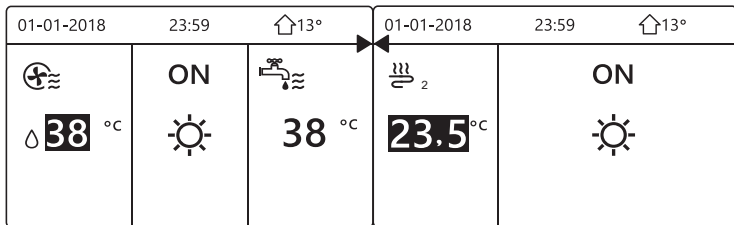

01-01-2018		23:59		🏠 13°		01-01-2018		23:59		🏠 13°	
⊕		<b>OFF</b>		🚰		⇐ 2		<b>OFF</b>		☀️	
Δ <b>38</b> °C		☀️		<b>38</b> °C		<b>23.5</b> °C				☀️	

Use the interface to turn on or off the unit for DHW. Press "▶️", "▼" on home page, the black cursor will appear:

01-01-2018		23:59		🏠 13°	
☁️		<b>ON</b>		🚰	
Δ <b>23</b> °C		☀️		<b>38</b> °C	

2) When the cursor is on DHW operation mode. Press "ON/OFF" key to turn on/off the DHW mode.

If the space operation is ON, then following pages will display:

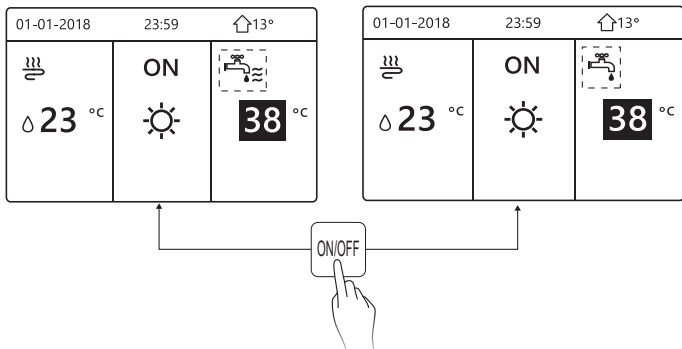

If the space operation mode is OFF, then following pages will display:

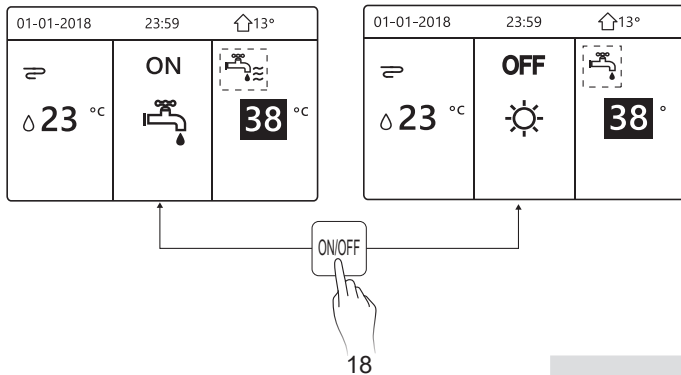

### 5.3 Adjusting the temperature

Press "◀", "▲" on home page, the black cursor will appear:

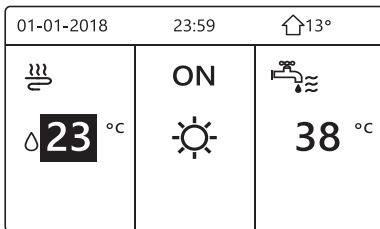

- If the cursor is on the temperature, use the "◀", "▶" to select and use "▼", "▲" to adjust the temperature.

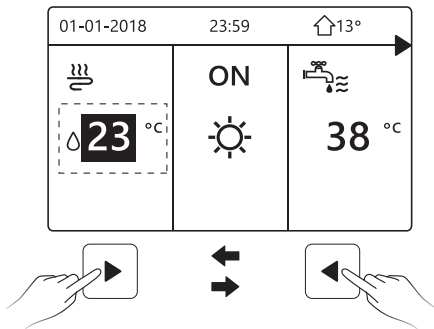

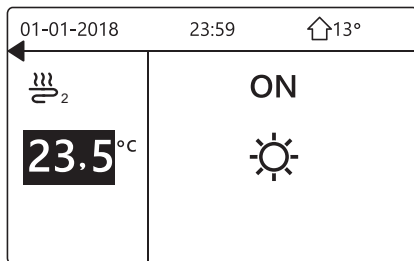
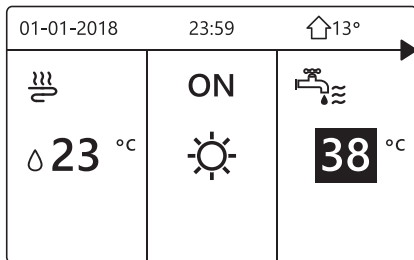

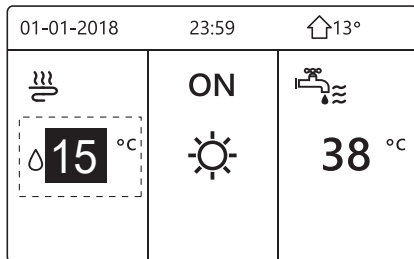
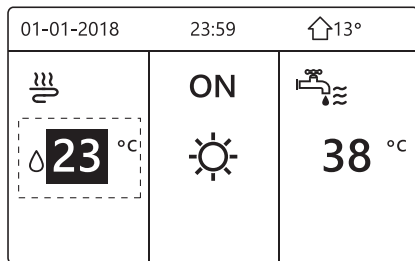

## 5.4 Adjusting space operation mode

- Adjusting space operation mode by interface. Go to "MENU" > "SPACE OPERATION MODE" . Press "OK", the following page will appear:

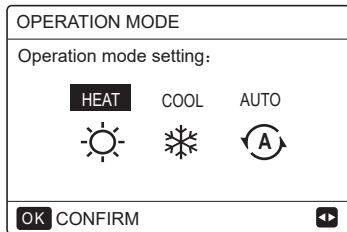

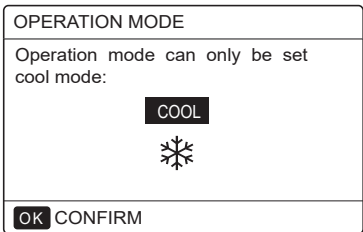
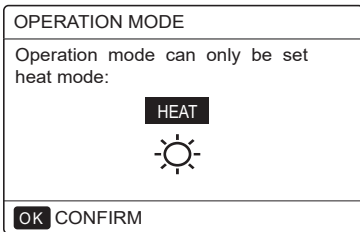

- There are three modes to be selected including HEAT, COOL and AUTO mode. Use the "◀", "▶" to scroll, press "OK" to select. Even if you don't press OK button and exit the page by pressing BACK button, the mode would still effective if the cursor have be moved to the operation mode.

If there is only HEAT(COOL) mode, the following page will appear:



- The operation mode can not be changed see cool MODE SETTING on installation and ower's manual.



If you select...	Then the space operation mode is...
 heat	Always heating mode
 cool	Always cooling mode
 auto	<p>Automatically changed by the software based on the outdoor temperature (and depending on installer settings of the indoor temperature), and takes monthly restrictions into account.</p> <p>Note: Automatic changeover is only possible under certain conditions.</p> <p>See the FOR SERVICEMAN&gt; AUTO MODE SETTING in "Installation and ower's manual (M-thermal split indoor unit)".</p>

- Adjust space operation mode by the room thermostat, see "ROOM THERMOSTAT" on "Installation and owner's manual (M-thermal split indoor unit)".

Go to MENU>OPERATION MODE, if you press any key to select or adjust, the follpage will appear:

01-01-2018	23:59	🏠13°
Cool/heat mode is controlled by the room thermostat.		
Please adjust the operation mode by the room thermostat.		
<b>OK</b> CONFIRM		

## 6 Network Configuration Guidelines

- The wired controller realizes intelligent control with a built-in module, which receives control signal from the APP.
- Before connecting the WLAN, please check for it if the router in your environment is active and make sure that the wired controller is well-connected to the wireless signal.
- During the Wireless distribution process, the LCD icon “” flashes to indicate that the network is being deployed. After the process is completed, the icon “” will be constantly on.

### 6.1 Wired Controller Setting

The wired controller settings include AP MODE and RESTORE WLAN SETTING.

WLAN SETTING
<b>AP MODE</b>
RESTORE WLAN SETTING
OK ENTER 

- Activate the WLAN by interface. Go to "MENU"> "WLAN SETTING"> "AP MODE".

Press"OK", the following page will appear:

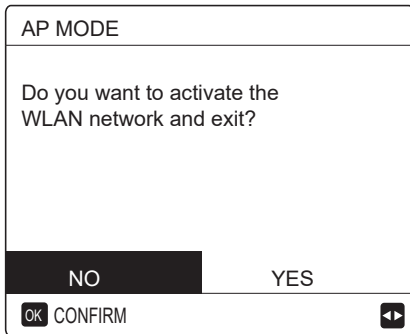

Use "◀", "▶" to move to"YES", press "OK" to select AP mode. Select AP Mode correspondingly on the mobile device and continue the follow-up settings according to the APP prompts.

### CAUTION

After enter Ap mode, if it's not connected with mobile phone, the LCD icon "📶" will flash 10 minutes then disappear.

If it's connected with the mobile phone, the icon "📶" will be constantly display.

- Restore WLAN setting by interface. Go to "MENU"> "WLAN SETTING" > "RESTORE WLAN SETTING" .

Press "OK", the following page will appear:

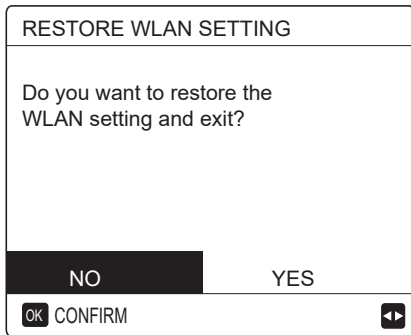

Use "◀", "▶" to move to "YES", press "OK" to restore WLAN setting. Complete the above operation and wireless configuration is reset.

## 6.2 Mobile Device Setting

AP Mode is available for wireless distribution on mobile device side.

- AP Mode connecting WLAN:

### 6.2.1 Install APP

- ① Scan the following QR code to install the Smart Home APP.



- ② Please research "Comfort Home" in APP STORE or GOOGLE PLAY to install the APP.

This APP is only applicable to Android 7.0 and IOS7, or newer operation systems.

## 6.2.2 Sign in/Sign up

Please input your registration code.

Or scan the QR code on the controller packaging box if existed.

And register your account according to the guidance.

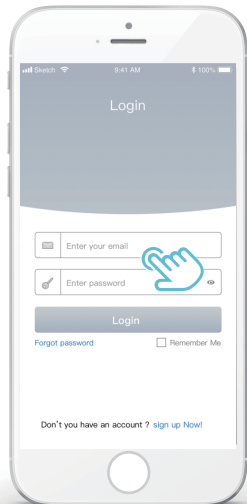
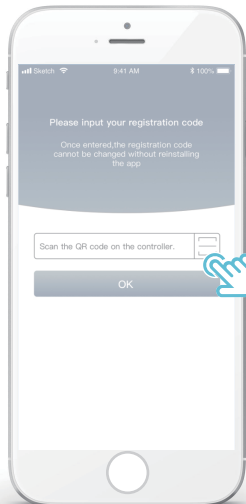

## 6.2.3 Add Home Appliances:

- 1) Add your device following the guidance.

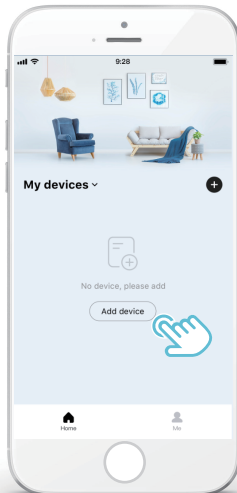

## 2) Operate the wired controller according to APP prompts.

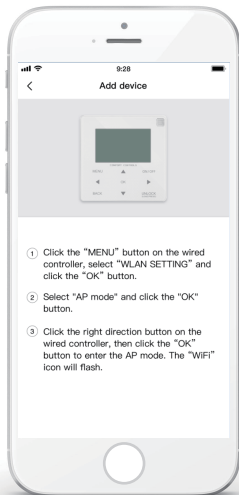

3) Wait for the home appliance to connect, and click “Sure”.

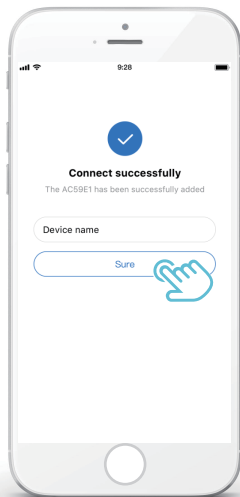

- 4) After the appliance is successfully connected, the LCD icon “



## Warning and troubleshooting for networking failures

When the product is connected to the network, please make sure that the phone is as close as possible to the product.

---

We only support 2.4GHz band routers at present.

---

Special characters (punctuation, spaces, etc.) are not recommended as part of the WLAN name.

---

It is recommended that you connect no more than 10 devices to a single router lest home appliances are affected by weak or unstable network signal.

---

If the password of the router or WLAN is changed, clear all settings and reset the appliance.

---

The contents of APP might change in version updates and actual operation shall prevail.

### WIFI information

WIFI transmit frequency range:2.400~2.4835 GHz  
EIRP not more than 20dbm

## 7 INSTALLATION MANUAL

### 7.1 Safety precaution

- Read the safety precautions carefully before installing the unit.
- Stated below are important safety issues that must be obeyed.
- Conform there is no abnormal phenomena during test operation after complete, then hand the manual to the user.
- Meaning of marks:



#### **WARNING**

Means improper handling may lead to personal death or severe injury.

---



#### **CAUTION**

Means improper handling may lead to personal injury or property loss.



## WARNING

Please entrust the distributor or professionals to install the unit. Installation by other persons may lead to imperfect installation, electric shock or fire.

---

Strictly follow this manual.  
Improper installation may lead to electric shock or fire.

---

Reinstallation must be performed by professionals.  
Improper installation may lead to electric shock or fire.

---

Do not disassemble your heat pump at will.  
A random disassembly may cause abnormal operation or heating, which may result in fire.

## CAUTION

Do not install the unit in a place vulnerable to leakage of flammable gases.

Once flammable gases are leaked and left around the wired controller, fire may occur.

---

The wiring should adapt to the wired controller current.

Otherwise, electric leakage or heating may occur and result in fire.

---

The specified cables shall be applied in the wiring. No external force may be applied to the terminal.

Otherwise, wire cut and heating may occur and result in fire.

---

Do not place the wired remote controller near the lamps, to avoid the remote signal of the controller to be disturbed. (refer to the right figure)



## 7.2 Other Precautions

### 7.2.1. Installation location

Do not install the unit in a place with much oil, steam, sulfide gas. Otherwise, the product may deform and fail.

### 7.2.2 Preparation before installation

1) Check whether the following assemblies are complete.

No.	Name	Qty.	Remarks
1	Wired Controller	1	_____
2	Cross round head wood mounting screw	3	For Mounting on the Wall
3	Cross round head mounting screw	2	For Mounting on the Electrical Switch Box
4	Installation and Owner's Manual	1	_____
5	Plastic bolt	2	This accessory is used when install the centralized control inside the electric cabinet
6	Plastic expansion pipe	3	For mounting on the Wall

### 7.2.3 Note for installation of wired controller:

- 1) This installation manual contains information about the procedure of installing Wired Remote Controller. Please refer to Indoor Unit Installation Manual for connection between Wired Remote Controller and Indoor Unit.
- 2) Circuit of Wired Remote Controller is low voltage circuit. Never connect it with a standard 220V/380V circuit or put it into a same Wiring Tube with the circuit.
- 3) The shielded cable must be connected stable to the ground, or transmission may fail.
- 4) Do not attempt to extend the shielded cable by cutting, if it is necessary, use Terminal Connection Block to connect.
- 5) After finishing connection, do not use Megger to have the insulation check for the signal wire.

### **7.3 Installation procedure and matching setting of wired controller**

### 7.3.1 Structure size figure

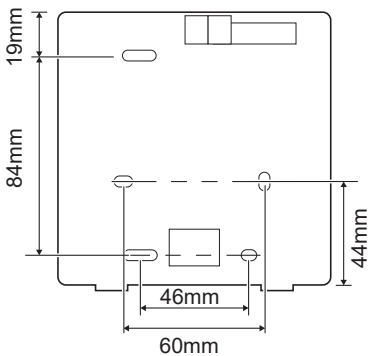
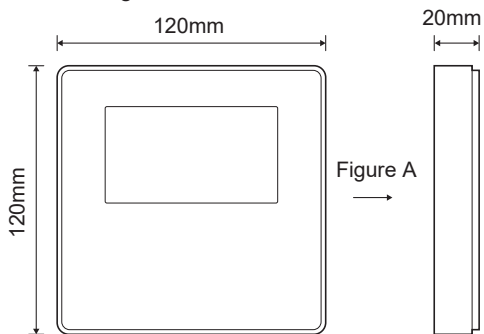

## 7.3.2 Wiring

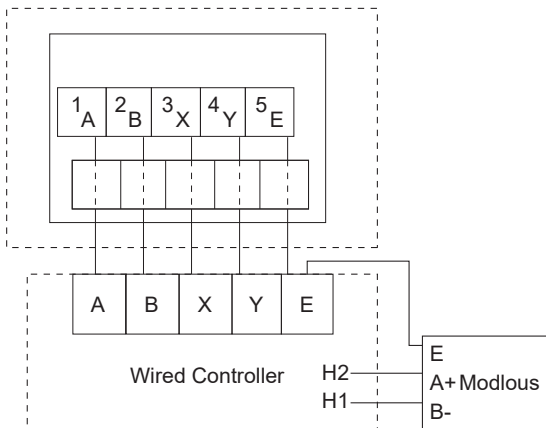

Input Voltage(A/B)	13.5VAC
Wiring size	0.75mm <sup>2</sup>

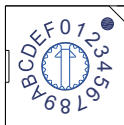

The rotating coded switch S3(0-F) on the main control board of hydraulic module is used for set the modbus address.

By default the units have this coded switch positioned=0, but this corresponds to the modbus address 16, while the others positions corresponds the number, e.g. pos=2 is address 2, pos=5 is address 5.

### 7.3.3 Back cover installation

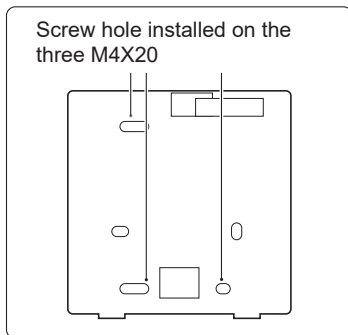
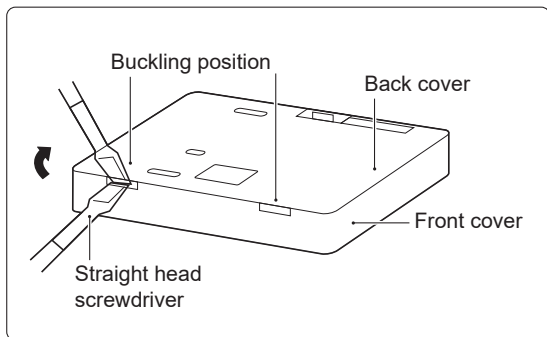

Screw hole installed on the  
three M4X20

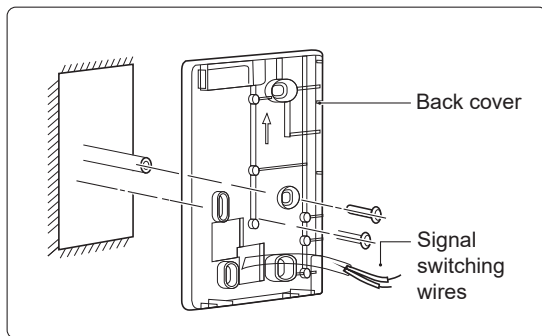
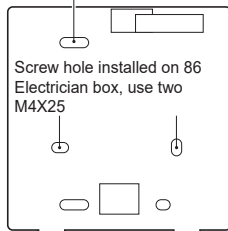

- 1) Use straight head screwdriver to insert in the buckling position in the bottom of wired controller, and spin the screwdriver to take down the back cover. (Pay attention to spinning direction, otherwise will damage the back cover!)
- 2) Use three M4X20 screws to directly install the back cover on the wall.
- 3) Use two M4X25 screws to install the back cover on the 86 electrician box, and use one M4X20 screws for fixing on the wall.
- 4) Adjust the length of two plastic screw bars in the accessory to be standard length from the electrical box screw bar to the wall. Make sure while installing the screw bar to the wall, making it as flat as the wall.
- 5) Use cross head screws to fix the wired controller bottom cover in the wall through the screw bar. Make sure the wired controller bottom cover is on the same level after installation, and then install the wired controller back to the bottom cover.
- 6) Over fastening the screw will lead to deformation of back cover.

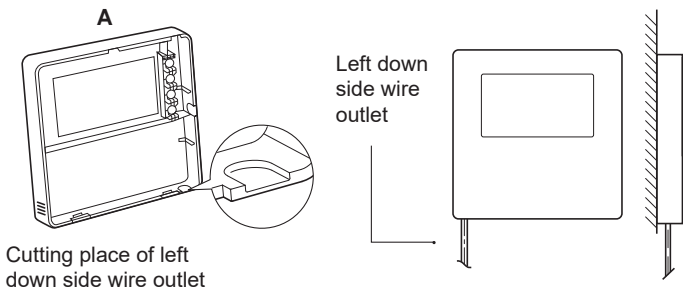

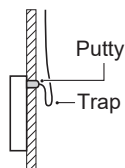
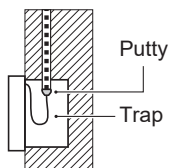
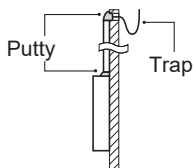
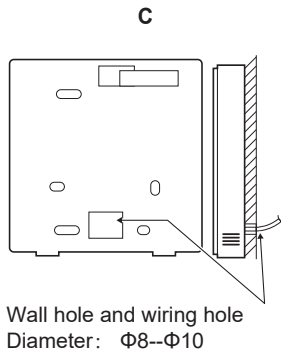
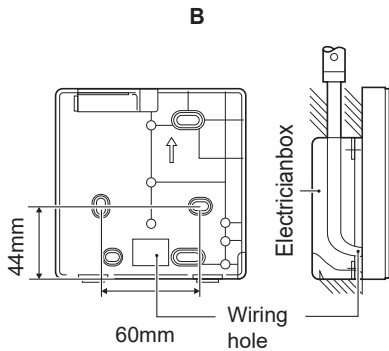

Avoid the water enter into the wired remote controller, use trap and putty to seal the connectors of wires during wiring installation.

## 7.4 Front cover installation

After adjusting the front cover and then buckle the front cover; avoid clamping the communication switching wire during installation.

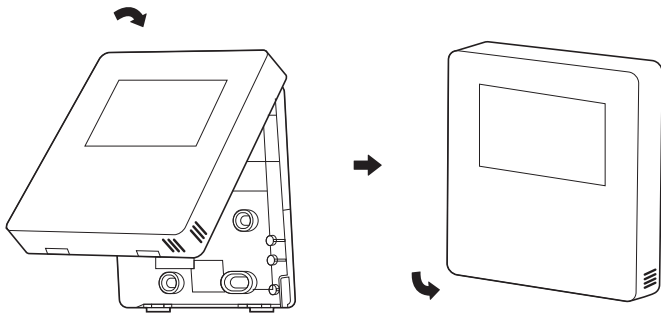

Sensor can not be affected with damp.

Correct install the back cover and firmly buckle the front cover and back cover, otherwise will make the front cover drop off.



## **8 MODBUS MAPPING TABLE**

### **8.1 Modbus Port Communication Specification**

Port: RS-485; the wired controller XYE is the communication port for connecting with the hydraulic module. H1 and H2 are the Modbus communication ports.

Communication address: It is consistent with the DIP switch address of the hydraulic module.

Baud rate: 9600.

Number of digits: Eight

Verification: none

Stop Bit: 1 bit

Communication protocol: Modbus RTU (Modbus ASCII is not supported)

### 8.1.1 Mapping of registers in the wired controller

The following addresses can use 03H, 06H (write single register), 10H (write multiple register)

Register address	Description	Remarks	
0 (PLC:40001)	Power on or off.	BIT15	Reserved
		BIT14	Reserved
		BIT13	Reserved
		BIT12	Reserved
		BIT11	Reserved
		BIT10	Reserved
		BIT9	Reserved
		BIT8	Reserved
		BIT7	Reserved
		BIT6	Reserved
		BIT5	Reserved
		BIT4	Reserved
		BIT3	0: power off heat pump; 1: power on heat pump(zone 2)
		BIT2	0: DHW(T5S) power off; 1: DHW(T5S) power on
		BIT1	0: power off heat pump; 1: power on heat pump(zone 1)
		BIT0	0: power off floor heating; 1: power on floor heating

1 (PLC:40002)	Setting the mode	1: Auto; 2: Cool; 3: Heat; Others: Invalid	
2 (PLC:40003)	Setting water temperature T1s	Water temperature T1s is corresponding to the floor heating.	
3 (PLC:40004)	Setting air temperature Ts	The room temperature range is between 17°C and 30°C, and is valid when there is Ta.	
4 (PLC:40005)	T5s	The water tank temperature range is between 40°C and 60°C.	
5 (PLC:40006)	Function setting	BIT15	Reserved
		BIT14	Reserved
		BIT13	Reserved
		BIT12	1: curve setting is enabled; 0: curve setting is disabled.
		BIT11	DHW pump's running constant-temperature water recycling
		BIT10	ECO mode
		BIT9	Reserved
		BIT8	Holiday home (the status can only be read, not changed)
		BIT7	0: Silent mode level1; 1: Silent mode level2
		BIT6:	Silent mode
		BIT5:	Holiday away (the status can only be read, but cannot be changed)
BIT4:	Disinfect		
BIT3:	Reserved		
BIT2:	Reserved		
BIT1:	Reserved		
BIT0:	Reserved		
6 (PLC:40007)	Curve selection	Curve 1-8	
7 (PLC:40008)	Forced water heating	0: Invalid 1: Forced on 2: Forced off	TBH is the electric water tank heater. IBH1 and 2 are the hydraulic module's rear electric heater. IBH1 and 2 can be activated together. TBH cannot be activated together with IBH1 and 2.
8 (PLC:40009)	Forced TBH		
9 (PLC:40010)	Forced IBH1		
10 (PLC:40011)	t_SG_MAX	0-24 Hours	

In cooling mode, T1S low temp setting range is 5~25°C; T1S high temp setting range is 18~25°C.  
In heating mode, T1S low temp setting range is 22~55°C; T1S high temp setting range is 35~60°C.

8.1.2 When the wired controller is connected to the hydraulic module, the parameters of the whole unit can be checked:

### ***Whole unit parameter mapping address table***

#### 1) Running parameters

Register address	Description	Remarks
100 (PLC:40101)	Operating frequency	Compressor operating frequency in Hz
101 (PLC:40102)	Operating Mode	Whole unit's actual operating mode, 2: cooling, 3: heating, 0: off
102 (PLC:40103)	Fan Speed	Fan speed, in r/min
103 (PLC:40104)	PMV openness	Openness of the outdoor unit's electronic expansion valve in P (only multiples of 8 are shown)
104 (PLC:40105)	Water inlet temperature	TW_in, in °C
105 (PLC:40106)	Water outlet temperature	TW_out, in °C
106 (PLC:40107)	T3 Temperature	Condenser temperature, in °C
107 (PLC:40108)	T4 Temperature	Outdoor ambient temperature in °C
108 (PLC:40109)	Discharge temperature	Compressor discharge temperature T <sub>p</sub> in °C
109 (PLC:40110)	Return air temperature	Compressor air return temperature in °C
110 (PLC:40111)	T1	Total water outlet temperature in °C
111 (PLC:40112)	T1B	System total water outlet temperature (behind the auxiliary heater) °C
112 (PLC:40113)	T2	Refrigerant liquid side temperature in °C
113 (PLC:40114)	T2B	Refrigerant gas side temperature in °C
114 (PLC:40115)	Ta	Room temperature, in °C
115 (PLC:40116)	T5	Water tank temperature
116 (PLC:40117)	Pressure 1	Outdoor unit high pressure value, in kPa
117 (PLC:40118)	Pressure 2	Outdoor unit low pressure value, in kPa
118 (PLC:40119)	Outdoor unit current	Outdoor unit operating current, in A
119 (PLC:40120)	Outdoor unit voltage	Outdoor unit voltage in V
120 (PLC:40121)	Hydraulic module current 1	Hydraulic module current 1 in A (reserved)
121 (PLC:40122)	Hydraulic module current 2	Hydraulic module current 2 in A (reserved)
122 (PLC:40123)	Compressor operating time	Compressor operating time in hour
123 (PLC:40124)	Reserved	Reserved
124 (PLC:40125)	Current fault	Check the code table for detailed fault codes
125 (PLC:40126)	Fault 1	Check the code table for detailed fault codes.
126 (PLC:40127)	Fault 2	
127 (PLC:40128)	Fault 3	

128 (PLC:40129)	Status bit 1	BIT15	Reserved
		BIT14	Reserved
		BIT13	Reserved
		BIT12	Reserved
		BIT11	EUUV 1:free electricity; 0:judge by SG's signal
		BIT10	SG 1:normal electricity; 0:high price electricity (judge when EUUV is 0)
		BIT9	Reserved
		BIT8	Solar energy signal input
		BIT7	Room temperature controller cooling
		BIT6:	Room temperature controller heating
		BIT5:	Outdoor unit test mode mark
		BIT4:	Remote On/Off (1: d8)
		BIT3:	Oil return
		BIT2:	Anti-freezing
BIT1:	Defrosting		
BIT0:	Reserved		
129 (PLC:40130)	Load output	BIT15	DEFROST
		BIT14	External heater
		BIT13	RUN
		BIT12	ALARM
		BIT11	Solar water pump
		BIT10	HEAT4
		BIT9	SV2
		BIT8	Mixed water pump P_c
		BIT7	Water return water P_d
		BIT6:	External water pump P_o
		BIT5:	Reserved
		BIT4:	SV1
		BIT3:	Water pump PUMP_I
		BIT2:	Electric heater TBH
BIT1:	Reserved		
BIT0:	Electric heater IBH1		
130 (PLC:40131)	Whole unit version No.	1-99 is the whole unit's version number and refers to the hydraulic module's version number.	
131 (PLC:40132)	Wired controller version No.	1-99 is the wired controller's version number.	

132 (PLC:40133)	Unit target frequency	
133 (PLC:40134)	Dc bus current	In A
134 (PLC:40135)	Dc bus voltage	The actual value/10, in V
135 (PLC:40136)	TF module temperature	Feedback on outdoor unit,in °C
136 (PLC:40137)	Hydraulic module curve T1S calculated value 1	The corresponding calculated value of zone 1
137 (PLC:40138)	Hydraulic module curve T1S calculated value 2	The corresponding calculated value of zone 2
138 (PLC:40139)	Water flow	The actual value*100, in m <sup>3</sup> /H
139 (PLC:40140)	Limit scheme of outdoor unit current	Scheme value
140 (PLC:40141)	Ability of Hydraulic module	The actual value*100, in kW

## 2) Parameter setting

Register address	Description	Remarks	
200 (PLC:40201)	Home appliance type	The upper 8 bit is the home appliance type: Central heating: 0x07	
201 (PLC: 40202)	Temperature upper limit of T1S cooling		
202 (PLC: 40203)	Temperature lower limit of T1S cooling		
203 (PLC: 40204)	Temperature upper limit of T1S heating		
204 (PLC: 40205)	Temperature lower limit of T1S heating		
205 (PLC: 40206)	Temperature upper limit of TS setting		
206 (PLC: 40207)	Temperature lower limit of TS setting		
207 (PLC: 40208)	Temperature upper limit of water heating		
208 (PLC: 40209)	Temperature lower limit of water heating		
209 (PLC: 40210)	PUMP RUNNING TIME	DHW PUMP water return running time. It is five minutes by default and can be adjusted between 5 and 120 min at an interval of 1 min.	
210 (PLC: 40211)	Parameter setting 1	BIT15	Enable water heating
		BIT14	Supports water tank electric heater TBH(Read-only)
		BIT13	Supports disinfection
		BIT12	DHW PUMP, 1: supported; 0: not supported
		BIT11	Reserved
		BIT10	DHW pump supports Pipe Disinfect
		BIT9	Enable cooling
		BIT8	T1S cooling high/low temperature settings(Read-only)
		BIT7	Enable heating
		BIT6:	T1S heating high/low temperature settings(Read-only)
		BIT5:	Supports T1 sensor
		BIT4:	Supports room temperature Sensor Ta
		BIT3:	Supports room thermostat
		BIT2:	Room thermostat
BIT1:	Dual Room Thermostat, 0: not supported; 1: supported		
BIT0:	0: room cooling/heating first, 1: water heating first		

211 (PLC:40212)	Parameter setting 2	BIT15	Reserved
		BIT14	Reserved
		BIT13	Reserved
		BIT12	Reserved
		BIT11	Reserved
		BIT10	Reserved
		BIT9	Reserved
		BIT8	Define the port, 0=remote ON/OFF; 1=DHW heater
		BIT7	Smart grid, 0=NON; 1=YES
		BIT6:	Enable or disable the Tw2, 0=NON ; 1=YES
		BIT5:	Setting the high/low temperature of cooling mode T1S
		BIT4:	Setting the high/low temperature of heating mode T1S
		BIT3:	Double zone setting is valid
		BIT2:	Reserved
BIT1:	Reserved		
BIT0:	Reserved		
212 (PLC: 40213)	dT5_On	Default setting: 5°C, range: 2~10°C, setting interval: 1°C	
213 (PLC: 40214)	dT1S5	Default setting: 10°C, range: 5~40°C, setting interval: 1°C	
214 (PLC: 40215)	T_Interval_DHW	Default setting: 5 min, range: 5~30 min, setting interval: 1 min	
215 (PLC: 40216)	T4DHWmax	Default setting: 43°C, range: 35~43°C, setting interval: 1°C	
216 (PLC: 40217)	T4DHWmin	Default setting: -10°C, range: -25~5°C, setting interval: 1°C	
217 (PLC: 40218)	t_TBH_delay	Default setting: 30 min, range: 0~240 min, setting interval: 5 min	
218 (PLC: 40219)	dT5_TBH_off	Default setting: 5°C, range: 0~10°C, setting interval: 1°C	
219 (PLC: 40220)	T4_TBH_on	Default setting: 5°C, range: -5~20°C, setting interval: 1°C	
220 (PLC: 40221)	T5s_DI	Temperature of the disinfection water tank, range: 60~70°C, default setting: 65°C	

221 (PLC: 40222)	<b>t_DI_max</b>	Maximum disinfection duration, range: 90~300 min, default setting: 210 min
222 (PLC: 40223)	<b>t_DI_hightemp</b>	Disinfection high temperature duration, range: 5~60 min, default setting: 15 min
223 (PLC: 40224)	<b>t_interval_C</b>	Time interval of compressor start-up in cooling mode; range: 5~30 min, default setting: 5 min
224 (PLC: 40225)	<b>dT1SC</b>	Default setting: 5°C, range: 2~10°C, setting interval: 1°C
225 (PLC: 40226)	<b>dTSC</b>	Default setting: 2°C, range: 1~10°C, setting interval: 1°C
226 (PLC: 40227)	<b>T4cmax</b>	Default setting: 43°C, range: 35~46°C, setting interval: 1°C
227 (PLC: 40228)	<b>T4cmin</b>	Default setting: 10°C, range: -5~25°C, setting interval: 1°C
228 (PLC: 40229)	<b>t_interval_H</b>	Time interval of compressor start-up in the heating mode; range: 5~60 min, default setting: 5 min
229 (PLC: 40230)	<b>dT1SH</b>	Default setting: 5°C, range: 2~10°C, setting interval: 1°C
230 (PLC: 40231)	<b>dTSH</b>	Default setting: 2°C, range: 1~10°C, setting interval: 1°C
231 (PLC: 40232)	<b>T4hmax</b>	Default setting: 25°C, range: 20~35°C, setting interval: 1°C
232 (PLC: 40233)	<b>T4hmin</b>	Default setting: -15°C, range: -25~5°C, setting interval: 1°C
233 (PLC: 40234)	<b>T4_IBH_on</b>	Ambient temperature for enabling the hydraulic module auxiliary electric heating IBH, range: -15~10°C; default setting: -5°C
234 (PLC: 40235)	<b>dT1_IBH_on</b>	Temperature return difference for enabling the hydraulic module auxiliary electric heating IBH, range: 2~10°C; default setting: 5°C
235 (PLC: 40236)	<b>t_IBH_delay</b>	Delay time of enabling the hydraulic module auxiliary electric heating IBH, range: 15~120 min; default setting: 30 min

237 (PLC: 40238)	<b>T4_AHS_on</b>	Ambient temperature for enabling the external heater AHS, range: -15~10°C, setting interval: -5°C
238 (PLC: 40239)	<b>dT1_AHS_on</b>	Temperature return difference for enabling the external heater AHS, range: 2~10°C; default setting: 5°C

240 (PLC: 40241)	<b>t_AHS_delay</b>	Delay time for enabling the external heater AHS, range: 5~120 min; default setting: 30 min
------------------	--------------------	--------------------------------------------------------------------------------------------

241 (PLC: 40242)	t_DHWHP_max	Longest duration of water heating by the heat pump, range: 10~600 min, default setting: 120 min;
242 (PLC: 40243)	t_DHWHP_restrict	Duration of limited water heating by the heat pump, range: 10~600 min, default setting: 30 min;
243 (PLC: 40244)	T4autocmin	Default setting: 25°C, range: 20~29°C, setting interval: 1°C
244 (PLC: 40245)	T4autohmax	Default setting: 17°C, range: 10~17°C, setting interval: 1°C
245 (PLC: 40246)	T1S_H.A.H	In the holiday mode, setting of T1 in the heating mode, range: 20~25°C, default setting: 25°C
246 (PLC: 40247)	T5S_H.A.DHW	In the holiday mode, setting of T1 in the water heating mode, range: 20~25°C, default setting: 25°C
247 (PLC: 40248)	ECO parameter	Reserved, wrong address is reported when this register is queried
248 (PLC: 40249)	ECO parameter	Reserved, wrong address is reported when this register is queried
249 (PLC: 40250)	ECO parameter	Reserved, wrong address is reported when this register is queried
250 (P LC:40251)	ECO parameter	Reserved, wrong address is reported when this register is queried
251 (PLC: 40252)	Comfort parameter	Reserved, wrong address is reported when this register is queried
252 (P LC:40253)	Comfort parameter	Reserved, wrong address is reported when this register is queried
253 (PLC: 40254)	Comfort parameter	Reserved, wrong address is reported when this register is queried
254 (P LC:40255)	Comfort parameter	Reserved, wrong address is reported when this register is queried
255 (PLC: 40256)	t_DRYUP	Temperature rise day number, range: 4~15 days, default setting: 8 days
256 (PLC: 40257)	t_HIGHPEAK	Drying day number, range: 3~7 days, default setting: 5 days
257 (PLC: 40258)	t_DRYD	Temperature drop day number, range: 4~15 days, default setting: 5 days
258 (PLC: 40259)	T_DRYPEAK	Highest drying temperature, range: 30~55°C, default setting: 45°C
259 (PLC: 40260)	t_firstFH	Running time of floor heating for the first time, default setting: 72 hrs, range: 48-96 hrs
260 (PLC: 40261)	T1S (first floor heating)	T1S of floor heating for the first time, range: 25~35°C, default setting: 25°C

261 (PLC: 40262)	T1SetC1	Parameter of the ninth temperature curves for cooling mode, range:5~25 °C, default setting: 10 °C;
262 (PLC: 40263)	T1SetC2	Parameter of the ninth temperature curves for cooling mode, range:5~25 °C, default setting: 16 °C;
263 (PLC: 40264)	T4C1	Parameter of the ninth temperature curves for cooling mode, range:(-5)~46 °C, default setting: 35 °C;
264 (PLC: 40265)	T4C2	Parameter of the ninth temperature curves for cooling mode, range:(-5)~46 °C, default setting: 25 °C;
265 (PLC: 40266)	T1SetH1	Parameter of the ninth temperature curves for cooling mode, range:25~60 °C, default setting: 35 °C;
266 (PLC: 40267)	T1SetH2	Parameter of the ninth temperature curves for cooling mode, range:25~60 °C, default setting: 28 °C;
267 (PLC: 40268)	T4H1	Parameter of the ninth temperature curves for cooling mode, range:(-25)~30 °C, default setting: -5 °C;
268 (PLC: 40269)	T4H2	Parameter of the ninth temperature curves for cooling mode, range:(-25)~30 °C, default setting: 7 °C;
269 (PLC: 40270)		The type of power input limitation, 0=NON, 1~8=type 1~8, default:0
270 (PLC: 40271)	HB:t_T4_FRESH_C	range:0.5~6 hour, setting interval:0.5 hour, sending value=actual value*2
	LB:t_T4_FRESH_H	range:0.5~6 hour, setting interval:0.5 hour, sending value=actual value*2
271 (PLC: 40272)	T_PUMPI_DELAY	range:2~20 hour, setting interval:0.5 hour, sending value=actual value*2:
272 (PLC: 40273)	EMISSION TYPE	Bit12-15: The type of zone 2 end for cooling mode
		Bit8-11: The type of zone 1 end for cooling mode
		Bit4-7: The type of zone 2 end for heating mode
		Bit0-3: The type of zone 1 end for heating mode



## NOTE

---

A series of 18 horizontal dotted lines for writing notes.



16110600A04690 V1.0

**Imported/distributed by Black Sea Suppliers**  
**[www.blackseasuppliers.ro](http://www.blackseasuppliers.ro)**  
**Licensed by Hyundai Corporation Holdings, Korea**

此页不做菲林，只做说明  
材料；双胶纸80g  
大小；120\*120  
黑白印刷，内容清晰