

Technical Manual

Energy Recovery Ventilator

Models:

NBBQ-D1.5TFB
NBBQ-D2.5TFB
NBBQ-D3.5TFB
NBBQ-D5TFB
NBBQ-D6.5TFB
NBBQ-D8TFB
NBBQ-D10TFB



Attention





Please read this manual carefully before using the equipment



















Contents

Safety Considerations-----	3,4
Unit Specifications-----	5,6
Dimensioned Drawings-----	7,8
Installation Considerations-----	9,10,11
Electrical Installation-----	12
Wiring Diagrams-----	13,14
Commissioning Information-----	15
Controller Instruction-----	16 to 17
Maintenance -----	18

Safety Considerations







Please read the following safety instructions before installation. And ensure that the unit is installed correctly.
Please observe all instruction in order to avoid any injury or damage to equipment or property.

Safety attentions			
The following symbols indicate potential levels of caution.			
 Warning	Situations with a risk or death or serious injury.	 Attention	Situations with a risk of injury or equipment/property damage.
The following symbols indicate compliance which must be observed			
	Not allowed or Stop		Must follow  or obliged

 Warning			
	Installation to be carried out by qualified person, End Users must not install, move or re-install this equipment by themselves		An anti-bird net or similar device should be installed to outside vents. Ensure there are no obstructions to or in the ducts
	Installation engineers must follow this manual strictly. Improper action can create a health hazard and reduce efficiency of the unit		Fresh air vent must be far enough away from any flue gas discharge or areas where hazardous vapors are present
	Unit must be installed strictly following this manual and mounted to a weight bearing surface for the weight of the unit		Electric engineering must follow national regulations and the manual, use special cables. Less capacity cables and improper engineering can cause electric shock or fire.
	During maintenance or repair, the unit and circuit breaker must be switched off. Otherwise electric shock could occur.		Ground wire cannot be connected to gas pipe, water pipe, lighting rod or telephone line etc. Incorrect grounding can cause electric shock.
 Attention			
	Power cable and wires must be installed by a qualified electrical engineer. Improper connection can cause over heating. Fire and loss of efficiency.		To avoid condensation, insulation should be fitted to fresh air ducts. Other ducting may also require insulation depending on dew point conditions.
	Insulation between the metal ducting and wall penetration must be installed if the ducting penetrates metal wall cladding, to avoid risk of electric shock or current leakage.		The cover of wiring box must be pressed down and closed to avoid dust and dirt entering. Excess dust and dirt can cause overheating of terminals and result in fire or electric shock.
	Use only approved installation hardware and accessories. Failure to observe can result in fire risk, electric shock and equipment failure		Where the unit is positioned, at high level in a hot humid situation. Please ensure sufficient ventilation is available
	The outdoor ducts must be installed facing downwards to avoid rain water entering. Improper installation can cause water leakage.		Correctly sized MCB must be fitted to the unit suitable earth leakage protection should also be installed to avoid risk of electric shock or fire.

Safety Considerations

Safety Considerations

 Attention			
	Do not install the unit in an extremely humid conditions, as it may result in electric shock and pose a fire risk.		Do not use the units as the primary kitchen extract grease and fatty deposits can block the heat exchanger, filter and pose a fire risk.
	Don not install the unit in areas there any poisonous or caustic gases are present.		Do not install the unit near open flame as it may result in over heating and pose a fire risk
	Acidic or alkali environments can cause poisoning or a fire		Rated supply voltage must be maintained, otherwise this may cause fire.

Specifications

Model			NBBQ-D1.5TFB	NBBQ-D2.5TFB	NBBQ-D3.5TFB	NBBQ-D5TFB
Airflow	(m3/h)	L	100	200	300	400
		M	150	250	350	500
		H	150	250	350	500
External pressure	(Pa)	L	110	90	110	110
		M	118	105	118	130
		H	120	110	120	140
Enthalpy Eff.(%)	Cooling	L	65	71	70	72
		M	60	62	62	63
		H	60	62	62	63
	Heating	L	70	73	73	75
		M	63	65	65	67
		H	63	65	65	67
Temp.Eff.	%	L	80	81	82	81
		M	75	73	74	76
		H	75	73	74	76
Noise	dB(A)	L	25	27	31	29
		M	30	34	37	35
		H	31.5	34.5	37.5	39
Voltage (V)			220	220	220	220
Current (A)			0.5	0.56	0.72	0.96
Input Power (W)			105	117	150	200
Net Weight (KG)			23	25	31	36

Specifications

Model			NBBQ-D6.5TFB	NBBQ-D8TFB	NBBQ-D10TFB
Airflow	(m ³ /h)	L	550	680	840
		M	650	800	1000
		H	650	800	1000
External pressure	(Pa)	L	120	120	105
		M	150	125	120
		H	160	170	175
Enthalpy Eff.(%)	Cooling	L	67	71	68
		M	60	63	60
		H	60	63	60
	Heating	L	71	73	72
		M	65	65	62
		H	65	65	62
Temp.Eff.	%	L	82	80	80
		M	74	74	76
		H	74	74	76
Noise	dB(A)	L	37	37	36
		M	40	40	42
		H	43	43	44
Voltage (V)			220	220	220
Current (A)			1.7	2.8	3.3
Input Power (W)			355	585	690
Net Weight (KG)			60	60	79

Dimensioned Drawings

NBBQ-D1.5TFB to D3.5TFB Models

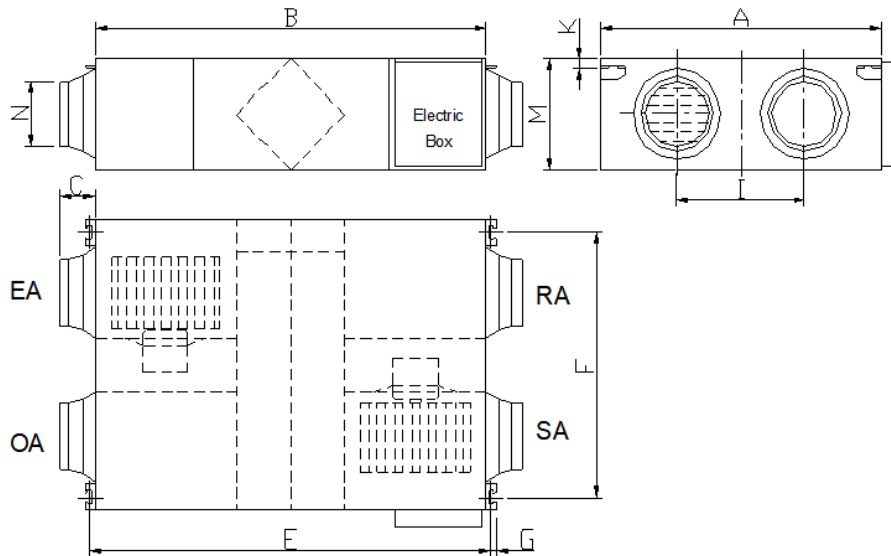

Model	A	B	C	E	F	G	I	K	M	N
NBBQ-D1.5TFB	580	666	100	725	510	19	290	20	264	φ144
NBBQ-D2.5TFB	599	744	100	675	657	19	315	111	270	Φ144
NBBQ-D3.5TFB	804	744	100	675	862	19	480	111	270	Φ144
NBBQ-D5TFB	904	824	107	754	960	19	500	111	270	φ194
NBBQ-D6.5TFB	884	1116	85	1045	940	19	428	170	388	φ242

NBBQ-D8TFB to D10TFB Models

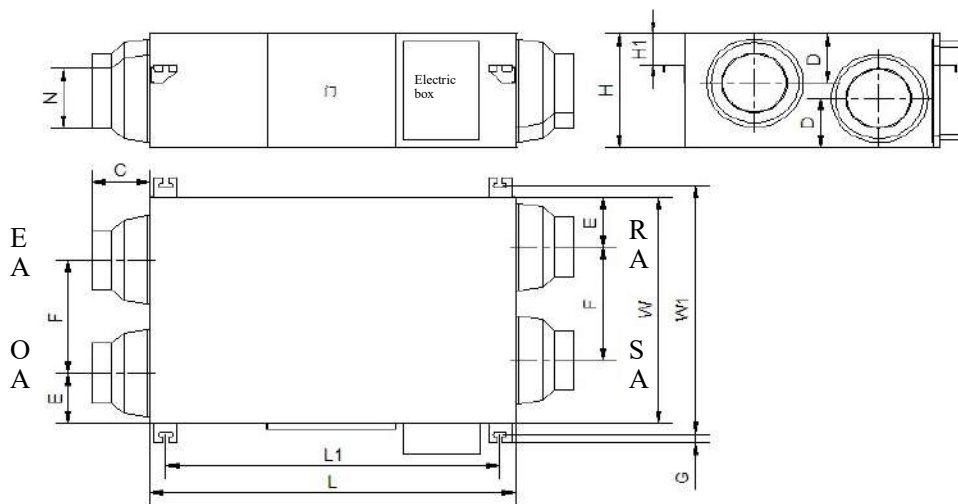

Model	L	L1	W	W1	H	H1	N	C	D	E	F	G
NBBQ-D8TFB	1126	1056	834	891	388	169	Φ242	86	157	152	436	21
NBBQ-D10TFB	1129	1060	1216	1273	388	171	Φ242	86	147	152	621	21

Installation Considerations

Installation Considerations

Protect the unit to avoid dust or other obstructions entering the unit and accessories during installation, or whilst in storage on site. Service ports should be installed to allow access for filter maintenance.

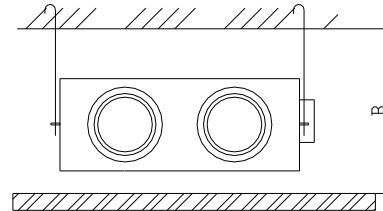
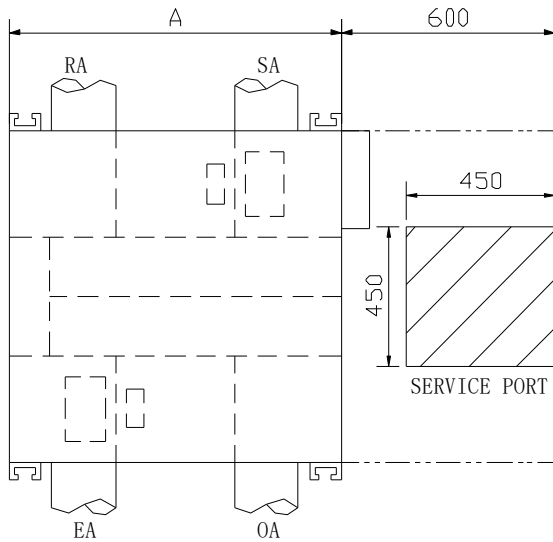

Model	A	Inner ceiling height B
NBBQ-D1.5TFB	580	320

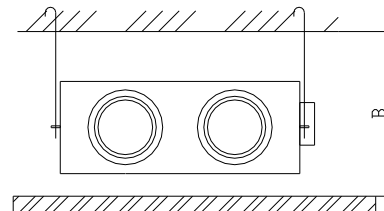
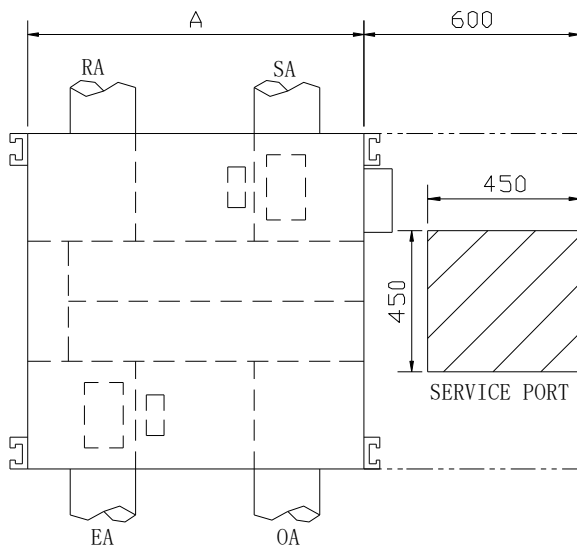

Model	A	Inner ceiling height B
NBBQ-D2.5TFB	599	320
NBBQ-D3.5TFB	804	320
NBBQ-D5TFB	904	320
NBBQ-D6.5TFB	884	450
NBBQ-D8TFB	834	450
NBBQ-D10TFB	1216	450

Installation Considerations

Installation Diagram

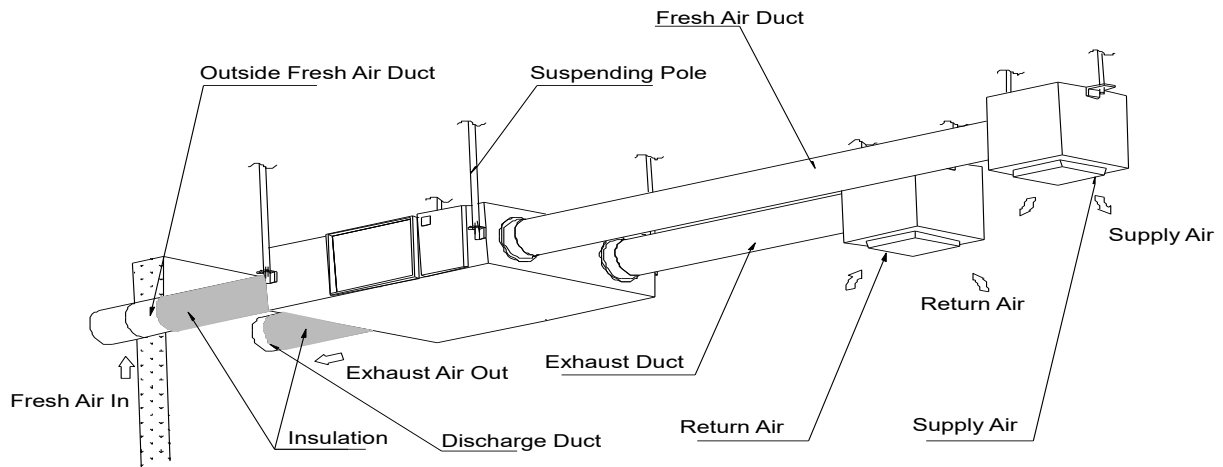

Physical Installation

1. Installer to prepare suitable threaded hangers with adjustable nuts and gaskets.
2. Install as shown by the image above. Installation must be level and securely fastened.
3. Failure to observe proper fixing could result in injury, equipment damage and excessive vibration. Uneven installation will also effect damper operation.

Notes for reverse installation of the unit
 4. Reverse labeling shows the unit is upside down.

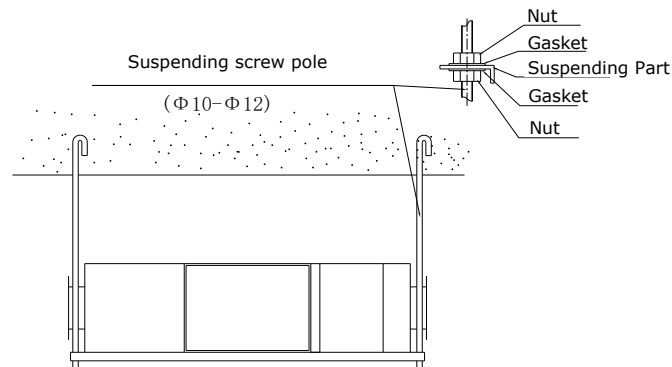

Ducting

1. Connection of unit vents and ducts should be taped or sealed to prevent air leakage, and should comply to relevant guidelines and regulations.
2. The two outdoor vents should face downward toward the outside to prevent any rain water ingress. (angle 1/100 1/50).
3. Insulation must be with the two ducts outside to prevent condensation.

Material: glass cotton, Thickness: 25mm

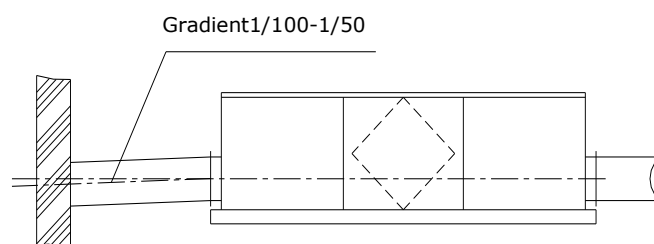

Installation Considerations

1. Be sure the ceiling height is no less than the Figures in above table B column.
2. Unit must not be installed close to boiler flues.
3. Following phenomenon should be avoided in the ducting installation.

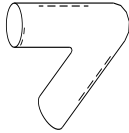

Severe bends

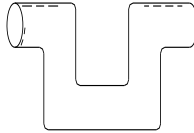

Multiple direction changes

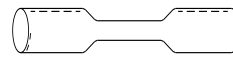

Multiple reducers/ crimped duct

4. Excessive use of flex-duct and long flex-duct runs should be avoided.
5. Fire dampers must be fitted as per national and local fire regulations.
6. Unit must not be exposed to ambient temperature above 40°C and should not face an open fire.
7. Take action to avoid dew and frost.

As shown by drawing below, unit will produce dew or frost when saturation curve is formed from A to C. Use pre-heater to ensure conditions are kept to right of the curve (B to B' , to move C to C') to prevent condensation or frost formation.

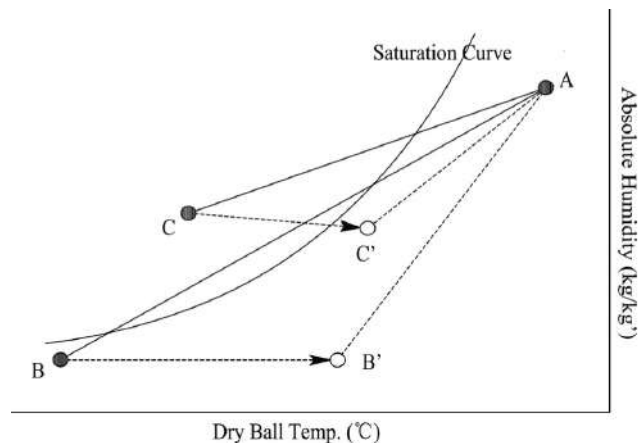

8. To avoid the outdoor exhaust air cycling back to indoor, the distance between the two vents installed on the outside wall should be over 1000mm.
9. If heater is equipped to the unit, operation of heater should be synchronous with the unit, so that the heater starts to work only when unit starts.
10. Duct muffler may be considered if user wants indoor noise to be minimized.

Electrical Installation

Warning

Power must be isolated during installation and before maintenance to avoid injury by electric shock. The specifications of cables must strictly match the requirements, otherwise it may cause performance failure and danger of electric shock or fire.

Power supply is AC220V/50HZ/1 Phase. Open the cover of electrical box, connect the 2 wires (L/N/) to the terminals and connect the cable of the control panel to the board according to the wiring diagram, and join the control panel to the cable.

Model	Spec. of power supply cable	Spec. of normal controller cable
NBBQ-D1.5TFB	2×1.5mm ²	2×0.5mm ²
NBBQ-D2.5TFB		
NBBQ-D3.5TFB		
NBBQ-D5TFB		
NBBQ-D6.5TFB		
NBBQ-D8TFB		
NBBQ-D10TFB		

Warning

We do not accept any liability for any problems caused by the user's self and non-authorized re-engineering to the electrical and control systems.

Model	Capacitor		Power Supply	Control Panel Model
NBBQ-D1.5TFB, NBBQ-D2.5TFB,	1.5μF	450V AC	220-240V/1Ph/50Hz	HDK-CK-20A
NBBQ-D3.5TFB	3μF	450V AC		
NBBQ-D5TFB	3.5μF	450V AC		
NBBQ-D6.5THB	8μF	450V AC		
NBBQ-D8TFB	8μF	450V AC		
NBBQ-D10TFB	10μF	450V AC		
NBBQ-D15TFB	8μF	450V AC		
NBBQ-D20TFB	10μF	450V AC		

Wiring Diagrams

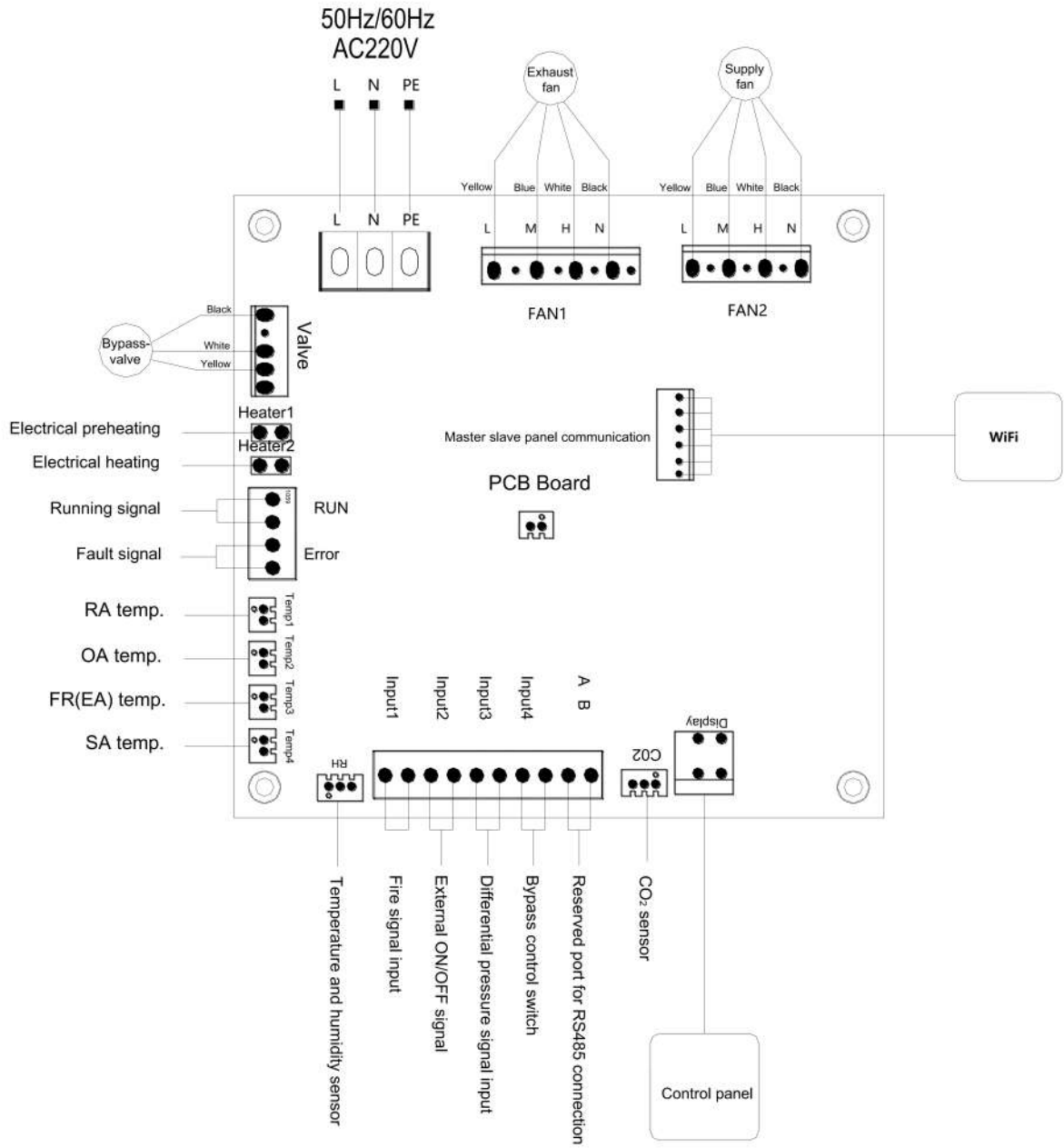













Precautions for Use

Commissioning

1. Check the wiring after the installation works are completed, and there must be commissioning.
2. Turn on the power supply, and carry out the commissioning and operation according to controller instructions. Check the working conditions of the blower, exhaust fan and bypass. The motor will stop running for more than 10 seconds when the bypass valve of the ventilator is operating.
3. When abnormalities occur in commissioning, it can be thought that the connection is wrong. To prevent electric shock, please turn off the special circuit breaker immediately and reconnect the wire correctly

Precautions for Use

 Warning			
	Loose or incorrect wiring connection can cause explosion or fire when the unit starts to work. Use only rated power voltage.		Don't put fingers or objects into vents of fresh air or exhaust air supply. Injury may be caused by the rotation of the impeller.
	Don't install, move or re-install the unit by yourself. Improper action may cause unit instability, electric shock or fire.		Don't change, disassemble or repair the unit by yourself. Improper action may cause electric shock or fire.
	Running the unit continuously in an abnormal status may cause failure, electric shock or fire.		Switch off the power and breaker when you clean the exchanger.
 Attention			
	Don't site intake supply vent in hot and humid conditions , as it may cause failure, current leakage or fire.		Don't put any burner directly facing the fresh air discharge, otherwise it may cause an insufficient burning.
	Isolate power during extended off periods Isolate power and take care when cleaning unit. (Risk of electric shock)		Observe guidelines and regulations relating to incomplete combustion when use is associated with fuel burning appliances.
	Clean the filter regularly. A blocked filter may result in poor indoor air quality.		

Touch Screen Controller Introduction

Display screen and Buttons

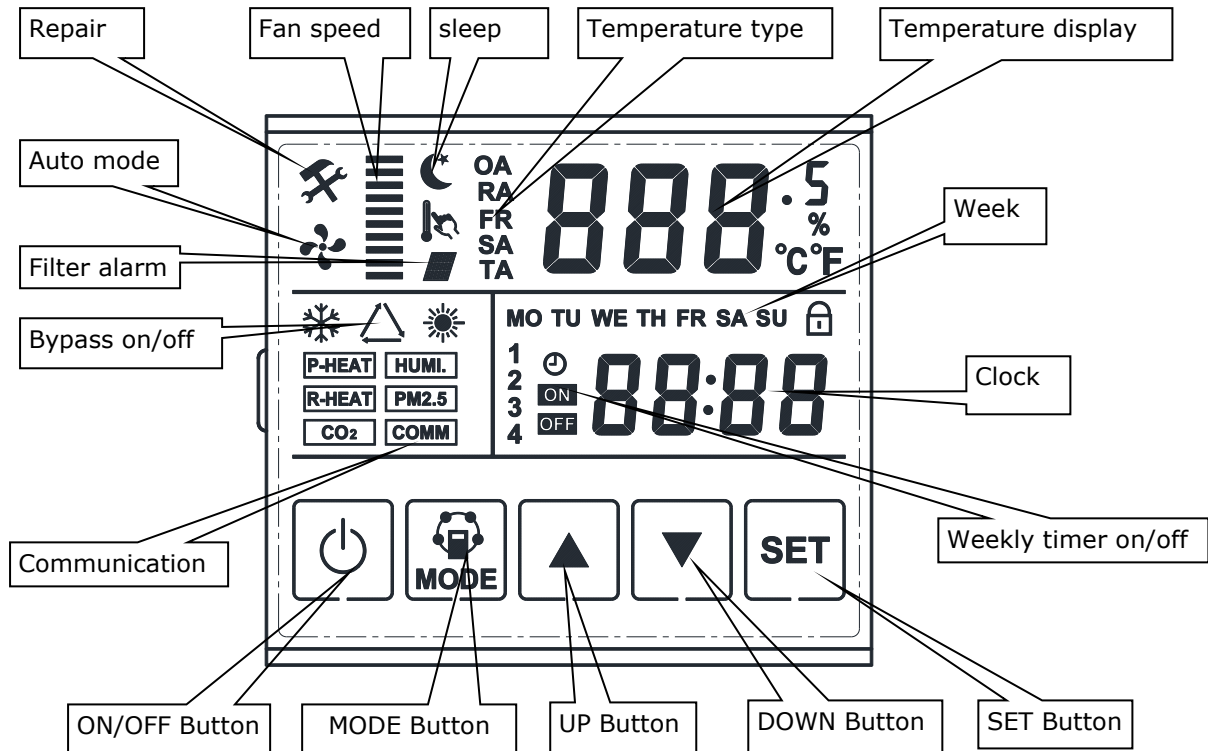

Operation Instructions

1. On/off button: turn on or turn off the equipment. When it is turned on, the back light of the display screen will be on, and it will be off if there is no operation within 30 seconds ;when the back light is off under the power on state, press any button and it will be on again ; press On/off button for more than 6 seconds to lock the screen, and press it again for more than 6 seconds to unlock it. Do not operate under the lock state. When the equipment is off, the display screen goes out. The air volume mode is kept as that before the machine is off when it is turned on again.

2. Press MODE to switch to display the detected items: the default interface in starting up is RA. Pressing lightly the MODE button, the users can choose or switch to the state of other detected items. The sequence is RA-OA-FR(EA)-SA-Setting-CO2-Humidity (indoor temperature - outdoor temperature - exhaust temperature - supply temperature - setting temperature - concentration of carbon dioxide - humidity) - timer on/off mode - sleep mode, which will be switched in cycle.

Interface display of timer on/off mode: time, week, timer on, timer off, air volume and indoor temperature.

Interface display of sleep mode: sleep icon, time, week and indoor temperature.

Touch Screen Controller Introduction

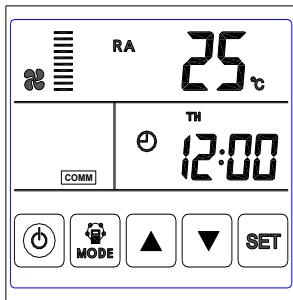

RA temperature

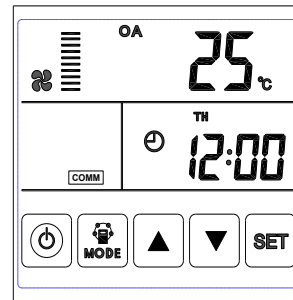

OA temperature

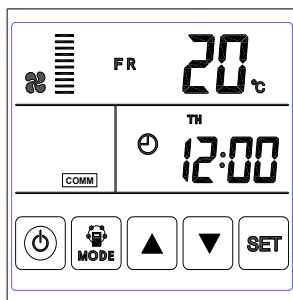

FR temperature

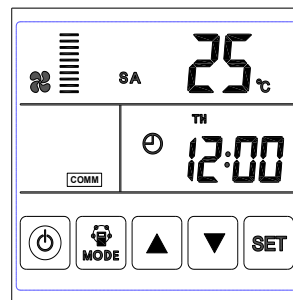

SA temperature

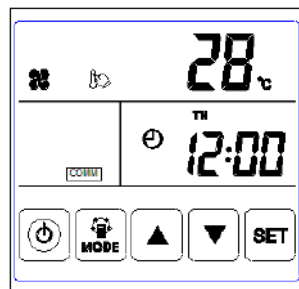

SA temperature setting

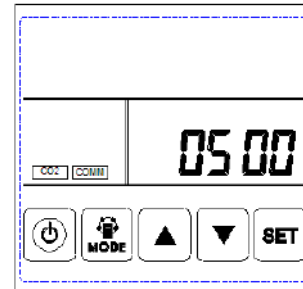

CO2 concentration

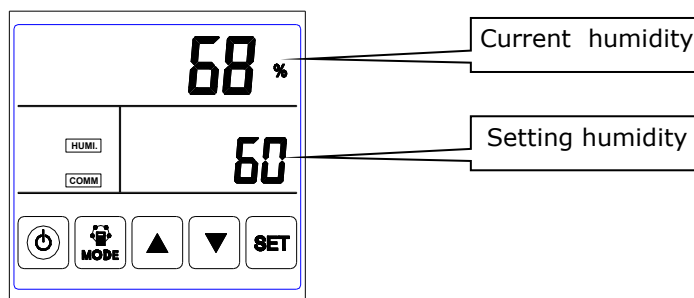

Humidity control

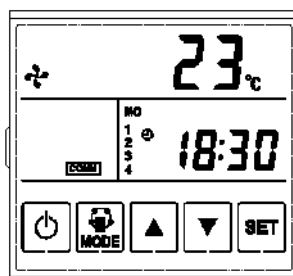

Timing on/off mode

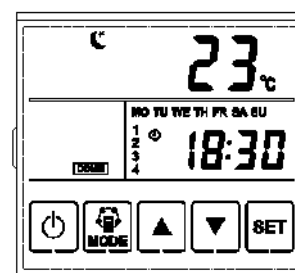

Sleep mode

Touch Screen Controller Introduction

3. Fan speed setting:

- 1) Fan speed setting in manual mode: under SA or FR temperature interface, press the arrow keys of “△” and “▽” to set the fan speed. The speed of exhaust fan can be set in "FR" interface, while the speed of the supply fan can be set in "SA" interface. There are 3 speeds of AC controller. For DC controller, there are 10 speeds.
- 2) Fan speed setting in automatic mode: four periods timer
It is allowed to set 4 periods per day, 7 days per week, under every time period, user can set a fan speed, then when the ventilator enter the very time period, it will automatically change the fan speed according to the setting.

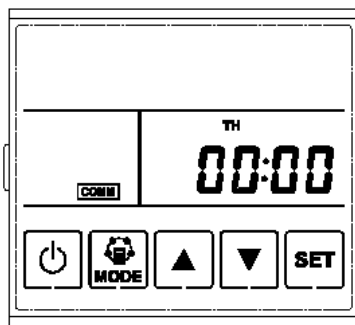

Time setting

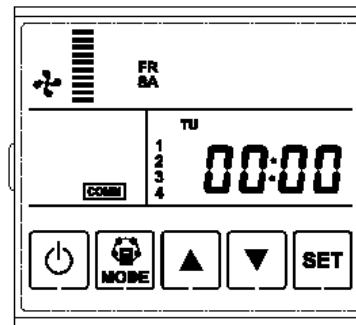

Timer setting

Time setting,

In the timer setting interface, long press the SET button to start time setting, at this time “hour” flashes. Press the up and down buttons to adjust the hours, after hours setting one, short press the SET button again to enter “minute” and “week” setting, under the same way to set “minute” and “week”, then press Mode button or On/off button to exit the setting.

Timer setting

In the timer mode interface, short press the SET button to start timer setting. At this time “week” flashes, press the UP and DOWN button to select the “week”, short press SET button to set the first period “hour”, press the UP and DOWN button to select the hour Short press SET button to set the “minute”, press the UP and DOWN button to select the minute Short press SET button to set the SA fan speed, press the UP and DOWN button to select the fan speed Short press SET button to set the EA fan speed, press the UP and DOWN button to select the fan speed

After the first period setting is done, system will automatically change to be the second period setting. After 4 periods setting is done, then system will automatically change to be week setting again. Repeat the setting like the above way then press the MODE button or On/off button to exit setting.

Note: if without operation for over 10 seconds, the system will exit setting automatically.

4. Bypass on/off setting:

Refer to the parameter list, the parameter number 2 is to switch manual bypass or auto bypass function. Value 0=manual bypass, value 1=auto bypass

- 1) Bypass on/off setting in manual mode: under OA temperature interface, press the arrow button of “△” for 6 seconds until the bypass icon appear, bypass open. While press the arrow button “▽” for 6 seconds, until the bypass icon disappear, bypass closed.

- 2) Automatic bypass function, refer to the parameter list number 3 and number 4, if the fresh air temperature within the X and X+Y, then bypass open, if fresh air temperature lower than X, or higher than X+Y, then bypass closed, i.e. by setting X=19, Y=3, then when fresh air between 19 and 22 celsius, bypass open, when fresh air lower than 19 celsius or higher than 22 celsius, bypass closed.

Touch Screen Controller Introduction

5. Temperature setting function: in temperature setting interface, press the arrow buttons of “△” and “▽” to adjust the setting temperature within the range of 15 to 30℃. If the supply air temperature is higher than the setting temperature, the electric heater will stop, and the p-heat and r-heat icons will disappear. If the supply air temperature is equal to or lower than the setting temperature (temperature difference within 5 celsius), the first stage electric heater will start and the p-heat icon appear, If the supply air temperature is 5 celsius lower than the setting temperature, the first and the second stages electric heater will both start and the p-heat and r-heat icons appear. If the supply air temperature is 2 celsius lower than the setting temperature, the second stage heater will stop, If the supply air temperature is higher than the setting temperature, 2 stage heaters stop. Please note that this function is only effective when the electric heater is connected to the PCB. And parameter number 5 (heater function) is set to be value 1 to active this function.

6. Setting parameters: long press the "MODE" button for more than 6 seconds under the power on state to enter into the interface for parameters setting.

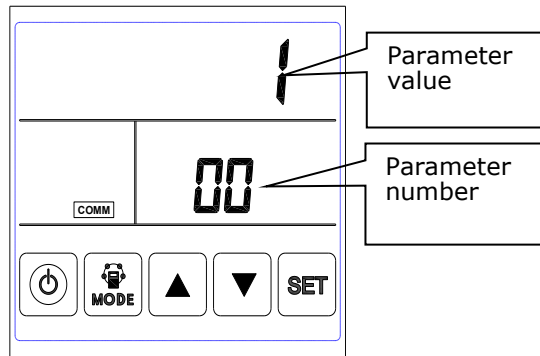

And then shortly press the "SET" button, the parameter number will increased accordingly. After choosing the corresponding parameter item, press the arrow buttons of “△” and “▽” to adjust the parameter values. When all setting is done, press the "SET" button to switch to the next item.

Attention:

- 1) After parameters setting, system need around 15 seconds to record, during this period power should not be off.
- 2) Please refer to below valid parameters table to set the suitable parameters according to different requests.

No.	Contents	Range	Default	Unit	Record Position
1	Power to auto restart	0 - invalid, 1-valid	1		Main control
2	Automatic bypass function	0 - invalid, 1-valid	0		Main control
3	Bypass opening temperature X	5-30	19	℃	Main control
4	Bypass opening temperature range Y	2-15	3	℃	Main control
5	Electric heating setting	0 Electric heating off 1 Electric heating on	0		Main control
6	Conventional defrosting	0 - invalid, 1-valid	1		Main control
7	Defrost interval	15-99	30	Minute	Main control
8	Defrost entering temperature	+5~-9	- 1	℃	Main control
9	Defrosting duration time	2-20	10	Minute	Main control
10	CO2 display/ valid/ invalid	0 - invalid, 1-valid	0		
11	CO2 sensor function	CO2 concentration	1500	800-2000	
12	Humidity display	0 - invalid, 1-valid	0		
13	Humidity sensor function	humidity setting	70	50-100	
14	IP address	1-66	1		
15	Fan speed control	1=3 speeds(AC) 2=10 speeds (DC)	1		

Touch Screen Controller Introduction

No.	Contents	Range	Default	Unit	Record Position
16	DC type selection	0: 150 air volume 1 : 250 air volume 2: 350 air volume 3: 200 air volume 4: 300 air volume 5: 400 air volume 6: 600 air volume 7: 800/1500 air volume 8: 1000/2000 air volume 9: 1300/2000 air volume	0		
17	Filter alarm	0 useless 1 clear filter alarm, and recount time	0		
18	Filter alarm setting	0:45 days 1:60 days 2:90 days 3:180 days	0		
19	Differential pressure switch function	0 - invalid, 1-valid	0		
20	Reserve				

A. Description of Parameter Item 02, 03 and 04 (automatic bypass function)

refer to the parameter list number 3 and number 4, if the fresh air temperature within the X and X+Y, then bypass open, if fresh air temperature lower than X, or higher than X+Y, then bypass closed, i.e. by setting X=19, Y=3, then when fresh air between 19 and 22 celsius, bypass open, when fresh air lower than 19 celsius or higher than 22 celsius, bypass closed.

B. Description of Parameter Item 06, 07, 08 and 09 (Conventional defrosting)

Conventional defrosting: when the EA temperature lower than the setting defrost temperature (the preset value is 1°C) and lasts for 1 minute, and it has been exceed the defrosting interval (the preset value is 30 minutes), the supply fan will stop and exhaust fan run at high speed, until the EA temperature is +15°C and lasts for 1 minute, or the defrosting has been lasting for a certain time (i.e. defrosting duration, whose preset value is 10 minutes), then the ventilator will turn back to the original operation state.

C. Description of Parameter Item 10 and 11 (CO2 sensor function)

When the ventilator is in stand by condition or any speeds that are not the highest speed, if CO2 sensor detects that the CO2 concentration is higher than the setting value for more than 5 seconds, the ventilator will start up automatically and run at high speed. Only when the CO2 concentration is lower than the setting value for more than 5 seconds. Ventilator will return to previous condition.

D. Description of Parameter Item 12 and 13 (Humidity sensor function)

When the ventilator is in stand by condition or any speeds that are not the highest speed, if humidity sensor detects that the humidity concentration is higher than the setting value for more than 5 seconds, the ventilator will start up automatically and run at high speed. Only when the humidity concentration is lower than the setting value for more than 5 seconds. Ventilator will return to previous condition.

Touch Screen Controller Introduction

7. Filter alarm, Parameter 18 to set the filter alarm time. When the operation time of the ventilator exceeds the setting time, the filter icon will flashes to remind user clean the filter. After cleaning, set Parameter 17 to be 1 to recount the time.

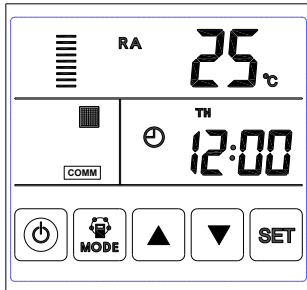

Filter alarm On

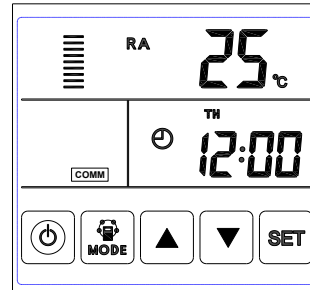

Filter alarm Off

8. Restore factory setting: In the power on state, press the buttons of “△” and “▽” simultaneously for more than 6 seconds to restore the product parameters to the factory default, ventilator will turn off after restore to factory default.

9. Error code checking: under the main interface, press the SET button for short, user can check the error code of ventilator, refer to below table. In fault display interface, press the buttons of “△” and “▽” to exit.

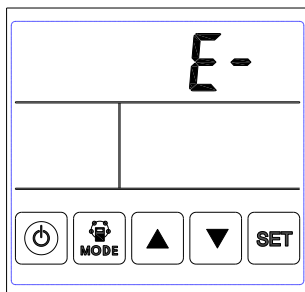

No Error

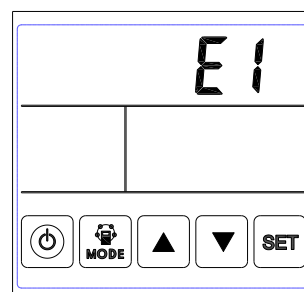

Error alarm

Code	Error
E1	OA temperature sensor error
E2	Memory error
E3	RA temperature sensor error
E4	EA temperature sensor error
E5	communication error
E6	SA temperature sensor error
E7	Fire alarm error

Touch Screen Controller Introduction

Modbus Protocol

Baud rate 9600bps,
Even/Odd No,
Data bit 8,
Stop bit 1,
communication interval > 200ms.
Support function code: 0x03, 0x06

Register address	readable	writable	range of value	function description	remarks,
0(0x0000)	√	√	0-1	on-off state 0 - off 1 - on	
1(0x0001)	√	√	1-10	Supply fan speed	
2(0x0002)	√	√	1-10	Exhaust fan speed	
3(0x0003)	√	√	15-30	Setting temperature	
4(0x0004)	√		0-100	Humidity %	
5(0x0005)	√		0-2000	CO2 ppm	
6(0x0006)	√		0-120	Fresh air temperature	Positive temperature, When reading value equal to or over 20, then actual temperature is "reading temperature minus 20"
7(0x0007)	√		0-120	Exhaust air temperature	
8(0x0008)	√		0-120	Supply air temperature	
9(0x0009)	√		0-120	Return air temperature	Negative temperature, When reading value less than 20, then actual temperature is "20 minus reading temperature"
10 (0x000a)	√		0	--	
11 (0x000b)	√		0-255	Bit0 fire alarm protection Bit1 OA temperature sensor error Bit2 EA temperature sensor error Bit3 RA temperature sensor error Bit4 SA temperature sensor error Bit5 humidity sensor error Bit6 CO2 sensor error Bit7 filter alarm	

Touch Screen Controller Introduction

12(0x000c)	√		0-1	Bypass switch, 1=on 0=off	
13(0x000d)	√		0-1	P-heating state 1=on 0=off	
14	√		0-1	R-Heating state 1=on 0=off	
15	√		0	0	
16	√		0	0	
17	√		0	0	
18	√		0	0	
19	√		0	0	
20	√		0	0	
21	√		0	0	
22	√	√	0-23	System time: hour	
23	√	√	0-59	System time: minute	
24	√	√	1-7	System time: Week	
25	√	√	1-99	IP address	

Maintenance

Warning

Power must be isolated before installation and maintenance to avoid injury or electric shock. Supply power cables, main circuit breaker and earth leakage protection, must comply with national regulations. Failure to observe could cause unit failure, electric shock or fire.

Standard filtration is supplied with this unit and must be used. Dust and dirt can accumulate in the heat exchanger if filters are removed. (This can lead to failure or decreased performance). To ensure efficient operation, regular cleaning or replacement of filters is required. Filter maintenance frequency will depend on working environment and unit running time.

Cleaning the filter

1. Open the access door
2. Remove the filters (from the side of the unit)
3. Vacuum the filters to get rid of the dust and dirt. For bad conditions dip it into water with soft wash to clean.
4. Push the filters to the positions after they get dried naturally, close the access door.
5. Change the filters if they are badly affected with dust and dirt or if they are broken.

Maintenance of heat exchanger

1. Pull off the filters first
2. Draw out the exchanger from the unit
3. Establish a cleaner schedule to clean the dust and dirt on the exchanger.
4. Install the exchanger and filters to their positions and close the access door.

Remarks: It is recommended maintenance of the exchanger is made every 3 years

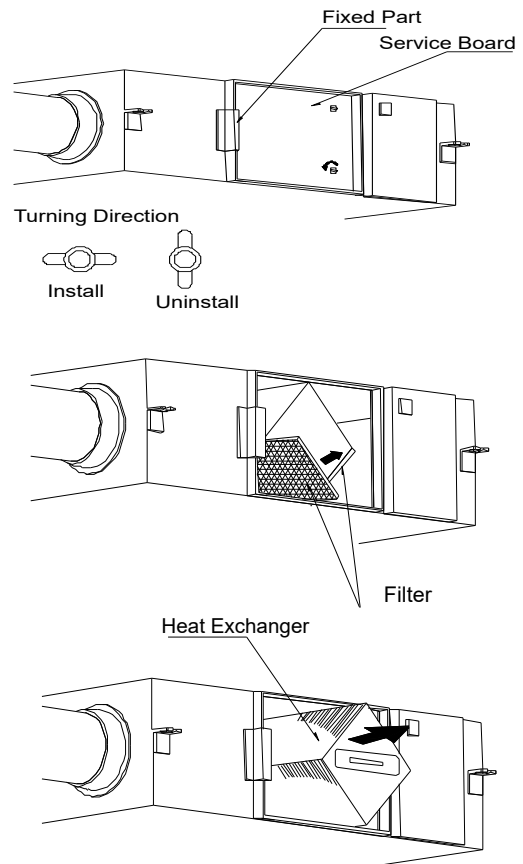

Failure diagnose

User can use the unit after trial operation. Before contacting us, you can make self trouble shooting following below chart in case of any failure.

Phenomenon	Possible reason	Solutions
The airflow volumes both indoor and outdoor vents drop obviously after a period of operation.	Dust and dirt blocking the filter	Replace or clean the filter
Noise comes from vents	Vents installation are losing.	Re-tightening the vents connections
Unit doesn't work	<ol style="list-style-type: none"> 1. No electricity 2. Protection breaker is cut 	<ol style="list-style-type: none"> 1. Guarantee power is on 2. Connect the breaker



ISO9000 ISO14001

Issue Date: June. 2018