

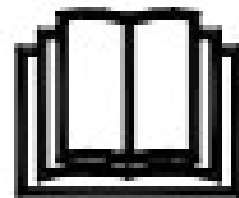

## DC Inverter Swimming Pool Heat Pump User and Service manual

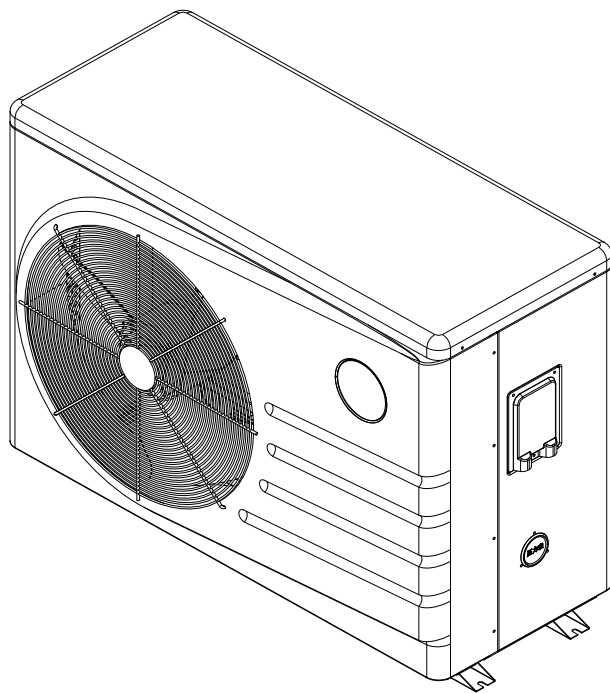

# Table of Contents

1. Specifications .....	7
2. Dimension .....	10
3. Installation and connection .....	12
4. Accessories .....	16
5. Electrical Wiring .....	16
6. Display Controller Operation .....	21
7. Troubleshooting .....	29
8. Maintenance .....	34
9. General Operating Guide.....	35
10. Owner Inspection.....	37
11. WiFi connection and configuration .....	37

Thank you for using swimming pool heat pump for your pool heating, it will heat your pool water and keep a constant temperature when the ambient air temperature is at - 20 to 43°C .

**▲ATTENTION: This manual includes all the necessary information about the use and the installation of your heat pump.**

The installer must read the manual and attentively follow the instructions of implementation and maintenance .

The installer is responsible for the installation of the product and should follow all the instructions of the manufacturer and the regulations in application . Incorrect installation against the manual implies the exclusion of the entire guarantee .

manufacturer declines any responsibility for the damage caused to people , object sand for errors due to the installation against the manual . Any use that isn't in accordance with the origin of its manufacturing will be regarded as dangerous.



**WARNING:**

Do not use means to accelerate the defrosting process or to clean . Other than those recommended by the manufacturer .

The appliance shall be stored in a room without continuously operating ignition sources (for example: open flames, an operating gas appliance or an operating electric heater.)

Do not pierce or burn.

Be aware that refrigerants may not contain an odour.

NOTE The manufacturer may provide other suitable examples or may provide additional information about the refrigerant odour .

Maximum working water pressure 0.6 MPa .

**WARNING:** If you stop running the heat pump, Please empty the water in heat pump always during winter time or when the ambient temperature drops below 0 °C, or else the Titanium exchanger will be damaged because of being frozen, in such case, your warranty will be lost.

**WARNING:** Please always cut the power supply if you want to open the cabinet to reach inside the heat pump, because there is high voltage electricity inside.

**WARNING:** Please keep the display controller in a dry area, or close the insulation cover to protect the display controller from being damaged by humidity.

This appliance is not intended for use by persons (including children) with reduced physical, sensory or mental capabilities, or lack of experience and knowledge, unless they have been given supervision or instruction concerning use of the appliance by a person responsible for their safety.

Children should be supervised to ensure that they do not play with the appliance.

The appliance intended to be permanently connected to the water mains and not connected by a hose -set.

The appliance shall be installed in accordance with national wiring regulations.

**WARNING:** Do not use means to accelerate the defrosting process or to clean, other than those recommended by the manufacturer.

The appliance shall be stored in a room without continuously operating ignition sources (for example: open flames, an operating gas appliance or an operating electric heater).

Pipe-work shall be protected from physical damage and, in the case of flammable refrigerants, shall not be installed in an unventilated space.

Compliance with national gas regulations shall be observed;

A warning to keep any required ventilation openings clear of obstruction;

A notice that servicing shall be performed only as recommended by the manufacturer;

A warning that ducts connected to an appliance shall not contain a potential ignition source;

Equipment piping in the occupied space shall be installed in such a way to protect against accidental damage in operation and service.

Precautions shall be taken to avoid excessive vibration or pulsation to refrigerating piping.

Protection devices, piping and fittings shall be protected as far as possible against adverse environmental effects, for example, the danger of water collecting and freezing in relief pipes or the accumulation of dirt and debris.

Provision shall be made for expansion and contraction of long runs of piping.

Equipment piping in the occupied space shall be installed in such a way to protect against accidental damage in operation and service.

Precautions shall be taken to avoid excessive vibration or pulsation to refrigerating piping.

Protection devices, piping and fittings shall be protected as far as possible against adverse environmental effects, for example, the danger of water collecting and freezing in relief pipes or the accumulation of dirt and debris.

Steel pipes and components shall be protected against corrosion with a rustproof coating before applying any insulation.

Flexible pipe elements shall be protected against mechanical damage, excessive stress by torsion, or other forces. They should be checked for mechanical damage annually.

The indoor equipment and pipes shall be securely mounted and guarded such that accidental rupture of equipment cannot occur from such events as moving furniture or reconstruction activities.

Where safety shut off valves are specified, the minimum room area may be determined based on the maximum amount of refrigerant that can be leaked as determined.

Where safety shut off valves are specified, the location of the valve in the refrigerating system relative to the occupied spaces shall be as described.

The manufacturer should specify other potential continuously operating sources known to cause ignition of the refrigerant used.

The appliance shall be stored so as to prevent mechanical damage from occurring.

The manual shall contain specific information about the required qualification of the working personnel for maintenance, service and repair operations. Every working procedure that affects safety means shall only be carried out by competent persons.

Examples for such working procedures are:

- breaking into the refrigerating circuit;
- opening of sealed components;
- opening of ventilated enclosure

Instructions for wiring to external zoning dampers and/or mechanical ventilation, to ensure that upon detection of a leak, the zoning dampers are driven fully open and additional mechanical ventilation is activated;

### **Checks to the area**

Prior to beginning work on systems containing flammable refrigerants, safety checks are necessary to ensure that the risk of ignition is minimized. For repair to the refrigerating system, the following precautions shall be completed prior to conducting work on the system.

### **Work procedure**

Work shall be undertaken under a controlled procedure so as to minimize the risk of a flammable gas or vapor being present while the work is being performed.

### **General work area**

All maintenance staff and others working in the local area shall be instructed on the nature of work being carried out. Work in confined spaces shall be avoided.

### **Checking for presence of refrigerant**

The area shall be checked with an appropriate refrigerant detector prior to and during work, to ensure the technician is aware of potentially toxic or flammable atmospheres. Ensure that the leak detection equipment being used is suitable for use with all applicable refrigerants, ie non-sparking, adequately sealed or intrinsically safe.

### **Presence of fire extinguisher**

If any hot work is to be conducted on the refrigerating equipment or any associated parts, appropriate fire extinguishing equipment shall be available to hand. Have a dry powder or CO2 fire extinguisher adjacent to the charging area.

### **No ignition sources**

No person carrying out work in relation to a refrigerating system which involves exposing any pipe work shall use any sources of ignition in such a manner that it may lead to the risk of fire or explosion. All possible ignition sources, including cigarette smoking, should be kept sufficiently far away from the site of installation, repairing, removing and disposal, during which refrigerant can possibly be released to the surrounding space. Prior to work taking place, the area around the equipment is to be surveyed to make sure that there are no flammable hazards or ignition risks. "No Smoking" signs shall be display.

### **Ventilated area**

Ensure that the area is in the open or that it is adequately ventilated before breaking into the system or conducting any hot work. A degree of ventilation shall continue during the period that the work is carried out. The ventilation should safely disperse any released refrigerant and preferably expel it externally into the atmosphere.

### **Checks to the refrigerating equipment**

Where electrical components are being changed, they shall be fit for the purpose and to the correct specification. At all times the manufacturer's maintenance and service guidelines shall be followed. If in doubt, consult the manufacturer's technical department for assistance.

### **Checks to electrical devices**

Repair and maintenance to electrical components shall include initial safety checks and component inspection procedures. If a fault exists that could compromise safety, then no electrical supply shall be connected to the circuit until it is satisfactorily dealt with. If the fault cannot be corrected immediately but it is necessary to continue operation, an adequate temporary solution shall be used. This shall be reported to the owner of the equipment so all parties are advised. Initial safety checks shall include:

- that capacitors are discharged: this shall be done in a safe manner to avoid possibility of sparking;

### **Repairs to sealed components**

- During repairs to sealed components, all electrical supplies shall be disconnected from the equipment being worked upon prior to any removal of sealed covers, etc. If it is absolutely necessary to have an electrical supply to equipment during servicing, then a permanent operating form of leak detection shall be located at the most critical point to warn of a potentially hazardous situation.

- Particular attention shall be paid to the following to ensure that by working on electrical components, the casing is not altered in such a way that the level of protection is affected. This shall include damage to cables, excessive number of connections, terminals not made to original specification, damage to seals, incorrect fitting of glands, etc.

- Ensure that the apparatus is mounted securely.

- Ensure that seals or sealing materials have not degraded to the point that they no longer serve the purpose of preventing the ingress of flammable atmospheres. Replacement parts shall be in accordance with the manufacturer's specifications.

### **Cabling**

Check that cabling will not be subject to wear, corrosion, excessive pressure, vibration, sharp edges or any other adverse environmental effects. The check shall also take into account the effects of aging or continual vibration from sources such as compressors or fans.

### **Detection of flammable refrigerants**

Under no circumstances shall potential sources of ignition be used in the searching for or detection of refrigerant leaks. A halide torch (or any other detector using a naked flame) shall not be used.

#### **Leak detection methods**

The following leak detection methods are deemed acceptable for all refrigerant systems.

Electronic leak detectors may be used to detect refrigerant leaks but, in the case of flammable refrigerants, the sensitivity may not be adequate, or may need re-calibration.

(Detection equipment shall be calibrated in a refrigerant-free area.) Ensure that the detector is not a potential source of ignition and is suitable for the refrigerant used. Leak detection equipment shall be set at a percentage of the LFL of the refrigerant and shall be calibrated to the refrigerant employed, and the appropriate percentage of gas (25 % maximum) is

confirmed. Leak detection fluids are also suitable for use with most refrigerants but the use of detergents containing chlorine shall be avoided as the chlorine may react with the refrigerant and corrode the copper pipe-work

If a leak is suspected, all naked flames shall be removed/extinguished. If a leakage of refrigerant is found which requires brazing, all of the refrigerant shall be recovered from the system, or isolated (by means of shut off valves) in a part of the system remote from the leak. Removal of refrigerant shall be according to Clause DD.9.

### **Removal and evacuation**

When breaking into the refrigerant circuit to make repairs – or for any other purpose – conventional procedures shall be used. However, for flammable refrigerants it is important that best practice is followed since flammability is a consideration.

The following procedure shall be adhered to:

- remove refrigerant;
- purge the circuit with inert gas (optional for A2L);
- evacuate (optional for A2L);
- purge with inert gas (optional for A2L);
- open the circuit by cutting or brazing.

The refrigerant charge shall be recovered into the correct recovery cylinders. For appliances containing flammable refrigerants other than A2L refrigerants, the system shall be purged with oxygen-free nitrogen to render the appliance safe for flammable refrigerants. This process may need to be repeated several times. Compressed air or oxygen shall not be used for purging refrigerant systems.

For appliances containing flammable refrigerants, other than A2L refrigerants, refrigerants purging shall be achieved by breaking the vacuum in the system with oxygen-free nitrogen and continuing to fill until the working pressure is achieved, then venting to atmosphere, and finally pulling down to a vacuum. This process shall be repeated until no refrigerant is within the system. When the final oxygen-free nitrogen charge is used, the system shall be vented down to atmospheric pressure to enable work to take place. This operation is absolutely vital if brazing operations on the pipe-work are to take place

Ensure that the outlet for the vacuum pump is not close to any potential ignition sources and that ventilation is available.

### **Charging procedures**

In addition to conventional charging procedures, the following requirements shall be followed.

- Ensure that contamination of different refrigerants does not occur when using charging equipment. Hoses or lines shall be as short as possible to minimize the amount of refrigerant contained in them.
- Cylinders shall be kept in an appropriate position according to the instructions.
- Ensure that the refrigerating system is earthed prior to charging the system with refrigerant.
- Label the system when charging is complete (if not already).
- Extreme care shall be taken not to overfill the refrigerating system. Prior to recharging the system, it shall be pressure-tested with the appropriate purging gas. The system shall be leak-tested on completion of charging but prior to commissioning. A follow up leak test shall be carried out prior to leaving the site.

## **Decommissioning**

Before carrying out this procedure, it is essential that the technician is completely familiar with the equipment and all its detail. It is recommended good practice that all refrigerants are recovered safely. Prior to the task being carried out, an oil and refrigerant sample shall be taken in case analysis is required prior to re-use of recovered refrigerant. It is essential that electrical power is available before the task is commenced.

- a) Become familiar with the equipment and its operation.
- b) Isolate system electrically.
- c) Before attempting the procedure, ensure that:
  - mechanical handling equipment is available, if required, for handling refrigerant cylinders;
  - all personal protective equipment is available and being used correctly;
  - the recovery process is supervised at all times by a competent person;
  - recovery equipment and cylinders conform to the appropriate standards.
- d) Pump down refrigerant system, if possible.
- e) If a vacuum is not possible, make a manifold so that refrigerant can be removed from various parts of the system.
- f) Make sure that cylinder is situated on the scales before recovery takes place.
- g) Start the recovery machine and operate in accordance with instructions.
- h) Do not overfill cylinders (no more than 80 % volume liquid charge).
- i) Do not exceed the maximum working pressure of the cylinder, even temporarily.
- j) When the cylinders have been filled correctly and the process completed, make sure that the cylinders and the equipment are removed from site promptly and all isolation valves on the equipment are closed off.
- k) Recovered refrigerant shall not be charged into another refrigerating system unless it has been cleaned and checked.

## **Labelling**

Equipment shall be labeled stating that it has been de-commissioned and emptied of refrigerant. The label shall be dated and signed. For appliances containing flammable refrigerants, ensure that there are labels on the equipment stating the equipment contains flammable refrigerant.

## **Recovery**

When removing refrigerant from a system, either for servicing or decommissioning, it is recommended good practice that all refrigerants are removed safely.

# 1. Specifications

Model	NBSPW06	NBSPW09	NBSPW12	NBSPW16
Operating air temperature (°C)	-20 ~43			
Performance Condition: Air 27°C, Water 26°C, Humidity 80%				
Heating capacity (kW)	6.0~1.6	9.0~2.2	12.0~3.0	16.0~3.5
Heating Capacity(Btu)	20470~5460	30700~6820	40940~10240	54590~11940
Consumed power (kW)	0.90~0.09	1.32~0.12	1.76~0.16	2.32~0.19
COP	6.7~18.5	6.8~18.4	6.8~18.6	6.9~18.7
COP at 50% capacity	10.2	10.1	10.3	10.4
Performance Condition: Air 15°C, Water 26°C, Humidity 70%				
Heating capacity (kW)	4.6~1.3	7.0~1.7	9.0~2.2	11.8~2.7
Heating Capacity(Btu)	15700~4435	23880~5800	30700~7500	40260~9210
Consumed power (kW)	1.17~0.20	1.51~0.24	2.05~0.29	2.62~0.37
COP	3.9~6.2	4.6~7.0	4.4~7.5	4.5~7.3
COP at 50% capacity	5.5	5.8	5.6	6.5
Performance Condition: Air 35 °C , Water 28 °C , Humidity 80%				
Cooling capacity (kW)	4.0	6.0	8.0	10.0
Consumed power (kW)	1.05	1.58	2.35	2.63
EER	3.8	3.8	3.4	3.8
Sound pressure at 1m dB(A)	36~48	38~49	40~50	43~53
Sound pressure of 50% capacity at 1m dB(A)	42	42	45	46
Sound pressure at 10m dB(A)	18~28	19~29	20~30	23~31
Heat exchanger	Spiral titanium tube in PVC			
Casing	ABS plastic casing black color			
Power supply	230V/1 Ph/50Hz/60Hz			
Water Connection (mm)	Φ50			
Max. power input(kW)	1.5	2.3	2.9	3.5
Max. current (A)	7.2	11.1	14.0	16.0
Advised water flux (m³/h)	2.6	3.9	5.2	6.9
Water Pressure Drop (max) kPa	2	5	9	9
Net weight/Gross weight(kg)	52/62	60/70	62/72	80/92
Body size(mm)	1036*410*605			1130*480*816
Refrigerant	R290/280g	R290/380g	R290/460g	R290/750g
Compressor	HIGHLY			
Four-way valve	Sanhua			
Expansion valve	Sanhua			
Operating water temperature (°C) *heating	9 ~40			
Operating water temperature (°C) *cooling	9 ~35			

Model	NBSPW20	NBSPW24	NBSPW29	NBSPW33
Operating air temperature (°C)	-20 ~43			
Performance Condition: Air 27°C, Water 26°C, Humidity 80%				
Heating capacity (kW)	20.0~4.0	24.2~5.3	28.6~8.3	33.1~8.5
Heating Capacity(Btu)	68240~13650	82570~18080	97583~28320	112937~27296
Consumed power (kW)	2.86~0.21	3.51~0.28	4.21~0.45	4.93~0.46
COP	7.0~18.8	6.9~18.7	6.8~18.6	6.7~18.5
COP at 50% capacity	10.3	10.1	10.2	10.1
Performance Condition: Air 15°C, Water 26°C, Humidity 70%				
Heating capacity (kW)	15~3.0	18.0~3.8	22.8~5.5	25.2~7.5
Heating Capacity(Btu)	51180~10230	61412~12960	77794~18766	85982~25590
Consumed power (kW)	3.33~0.44	4.0~0.52	4.91~0.81	5.36~1.15
COP	4.5~6.8	4.5~7.3	4.6~6.8	4.7~6.5
COP at 50% capacity	6.1	6.4	6.1	6.2
Performance Condition: Air 35 °C , Water 28 °C , Humidity 80%				
Cooling capacity (kW)	11.3	13.0	16.0	17.5
Consumed power (kW)	2.97	3.47	3.48	4.06
EER	3.8	3.8	4.60	4.3
Sound pressure at 1m dB(A)	43~54	44~56	47~58	48~60
Sound pressure of 50% capacity at 1m dB(A)	48	49	52	54
Sound pressure at 10m dB(A)	24~32	25~33	27~38	28~40
Heat exchanger	Spiral titanium tube in PVC			
Casing	ABS plastic casing black color			
Power supply	230V/1 Ph/50Hz/60Hz			
Water Connection (mm)	Φ50			
Max. power input(kW)	4.4	5.5	6.9	7.0
Max. current (A)	20.2	25.2	31.1	31.8
Advised water flux (m³/h)	8.6	10.1	12.04	14.2
Water Pressure Drop (max) kPa	14	19	20	20
Net weight/Gross weight(kg)	83/95	86/98	118/132	120/134
Body size(mm)	1130*480*816		1235*490*980	
Refrigerant	R290/850g	R290/1000g	R290/1500g	R290/1500g
Compressor	HIGHLY			
Four-way valve	Sanhua			
Expansion valve	Sanhua			
Operating water temperature (°C) *heating	9 ~40			
Operating water temperature (°C) *cooling	9 ~35			

Model	NBSPW24T	NBSPW29T	NBSPW33T
Operating air temperature (°C)	-20 ~43		
Performance Condition: Air 27°C, Water 26°C, Humidity 80%			
Heating capacity (kW)	24.2~5.3	28.6~8.3	33.1~8.5
Heating Capacity(Btu)	82570~18080	97583~28320	112937~27296
Consumed power (kW)	3.51~0.28	4.21~0.45	4.93~0.46
COP	6.9~18.7	6.8~18.6	6.7~18.5
COP at 50% capacity	10.1	10.2	10.1
Performance Condition: Air 15°C, Water 26°C, Humidity 70%			
Heating capacity (kW)	18.0~3.8	22.8~5.5	25.2~7.5
Heating Capacity(Btu)	61412~12960	77794~18766	85982~25590
Consumed power (kW)	4.0~0.52	4.91~0.81	5.36~1.15
COP	4.5~7.3	4.6~6.8	4.7~6.5
COP at 50% capacity	6.4	6.1	6.2
Performance Condition: Air 35 °C , Water 28 °C , Humidity 80%			
Cooling capacity (kW)	13.0	16.0	17.5
Consumed power (kW)	3.47	3.48	4.06
EER	3.8	4.60	4.3
Sound pressure at 1m dB(A)	44~56	47~58	48~60
Sound pressure of 50% capacity at 1m dB(A)	49	52	54
Sound pressure at 10m dB(A)	25~33	27~38	28~40
Heat exchanger	Spiral titanium tube in PVC		
Casing	ABS plastic casing black color		
Power supply	380V/3Ph/50Hz/60Hz		
Water Connection (mm)	Φ50		
Max. power input(kW)	5.5	6.9	7
Max. current (A)	9.8	12.3	12.5
Advised water flux (m³/h)	10.1	12.04	14.2
Water Pressure Drop (max) kPa	19	20	20
Net weight/Gross weight(kg)	86/98	118/132	120/134
Body size(mm)	1130*480*816	1235*490*980	
Refrigerant	R290/1000g	R290/1500g	R290/1500g
Compressor	HIGHLY		
Four-way valve	Sanhua		
Expansion valve	Sanhua		
Operating water temperature (°C) *heating	9 ~40		
Operating water temperature (°C) *cooling	9 ~35		

\* Above data are subjects to modification without notice .

## 2. Dimension

### 2.1 Unit mm

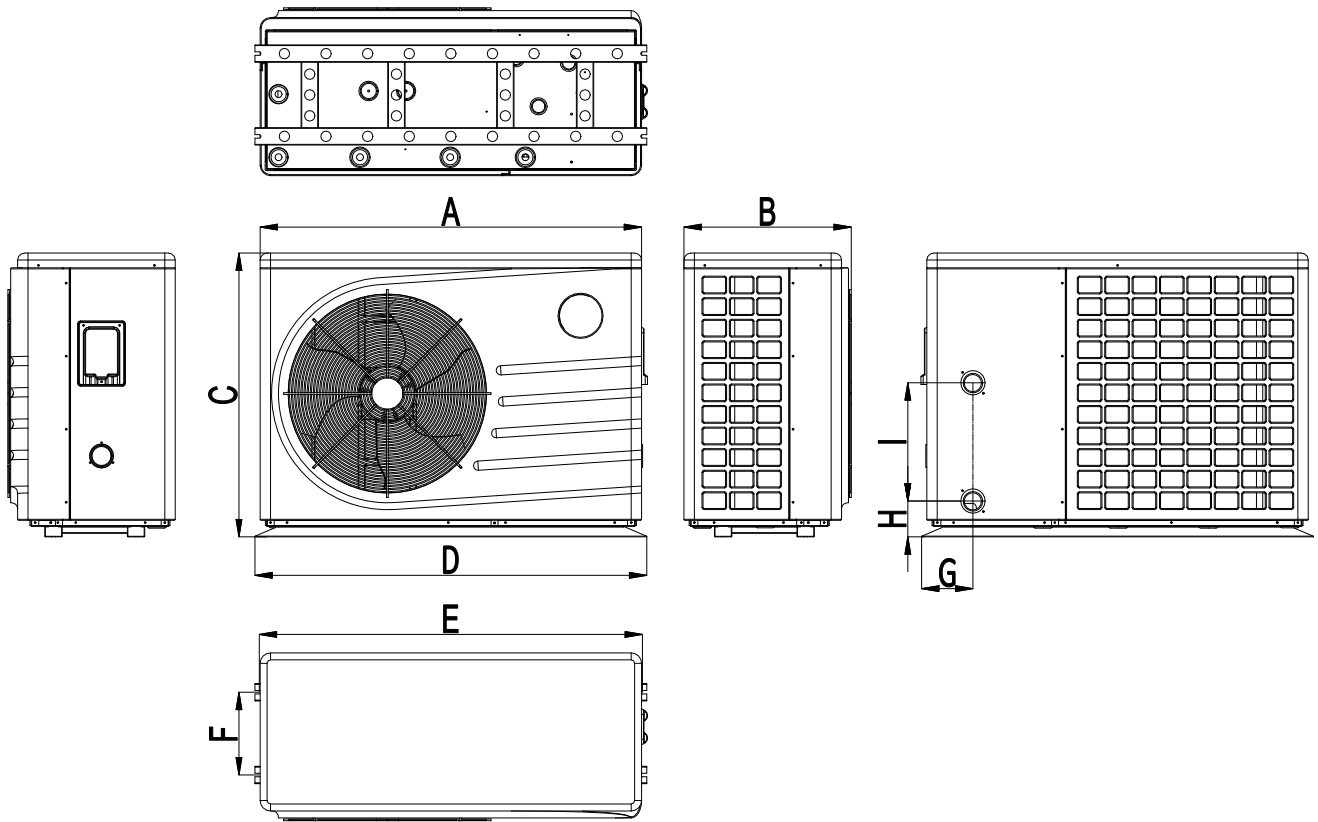

Model	A	B	C	D	E	F	G	H	I
<b>NBSPW06</b>	1006	410	605	1036	1021	180	141	102	250
<b>NBSPW09</b>	1006	410	605	1036	1021	180	147	102	300
<b>NBSPW12</b>	1006	410	605	1036	1021	180	147	102	300
<b>NBSPW16</b>	1100	480	816	1130	1105	238	148	102	340
<b>NBSPW20(T)</b>	1100	480	816	1130	1105	238	148	102	400
<b>NBSPW24(T)</b>	1100	480	816	1130	1105	238	148	102	470
<b>NBSPW29(T)</b>	1211	490	980	1235	1220	240	147	102	420
<b>NBSPW33(T)</b>	1211	490	980	1235	1220	240	147	102	470

### 2.2 Exploded views

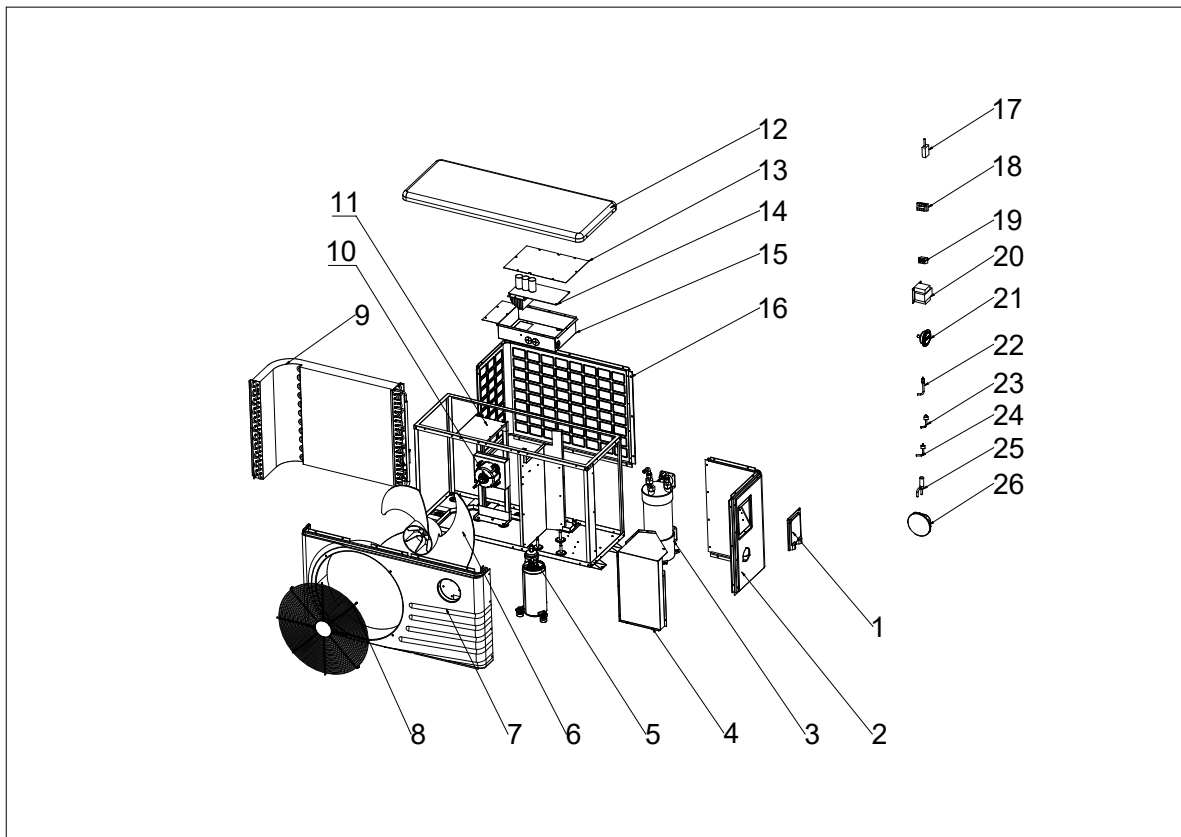

NO	Spare parts	NO	Spare parts
1	terminal block cover	16	behind panel
2	right side panel	17	R290 refrigerant leakage sensor
3	titanium foam	18	terminal block
4	noise suppressor cover	19	terminal block
5	compressor	20	electric reactor
6	fan blade	21	pressure gauge
7	front panel	22	needle valve
8	fan protection net	23	high pressure switch
9	finned heat-exchanger	24	low pressure switch
10	motor	25	electronic expansion valve
11	motor bracket	26	wired controller
12	top cover	27	needle valve
13	electric box cover		
14	driver board		
15	electric box		

### 3. Installation and connection

#### 3.1 Notes

The factory only supplies the heat pump. All other components, including a bypass if necessary, must be provided by the user or the installer.

#### Attention:

Please observe the following rules when installing the heat pump:

1. Any addition of chemicals must take place in the piping located **downstream** from the heat pump.
2. Install a bypass if the water flow from the swimming pool pump is more than 20% greater than the allowable flow through the heat exchanger of the heat pump.
3. Install the heat pump above the water level of the swimming pool.
4. Always place the heat pump on a solid foundation and use the included rubber mounts to avoid vibration and noise.
5. Always hold the heat pump upright. If the unit has been held at an angle, wait at least 24 hours before starting the heat pump.

#### 3.2 Heat pump location

The unit will work properly in any desired location as long as the following three items are present:

#### 1. Fresh air – 2. Electricity – 3. Swimming pool filters

The unit may be installed in virtually any **outdoor** location as long as the specified minimum distances to other objects are maintained (see drawing below). Please consult your installer for installation with an indoor pool. Installation in a windy location does not present any problem at all, unlike the situation with a gas heater (including pilot flame problems).

**ATTENTION:** Never install the unit in a closed room with a limited air volume in which the air expelled from the unit will be reused, or close to shrubbery that could block the air inlet. Such locations impair the continuous supply of fresh air, resulting in reduced efficiency and possibly preventing sufficient heat output. See the drawing below for minimum dimensions.

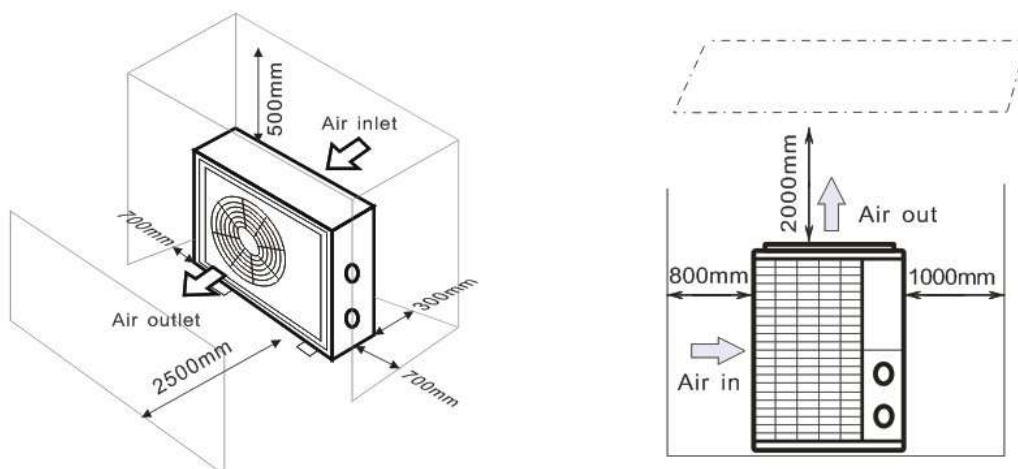

#### 3.3 Distance from your swimming pool

The heat pump is normally installed within a perimeter area extending 7.5 m from the swimming pool. The greater the distance from the pool, the greater the heat loss in the pipes. As the pipes are mostly underground, the heat loss is low for distances up to 30 m (15 m from and to the pump; 30 m in total) unless the ground is wet or the groundwater level is high. A rough estimate of the heat loss per 30 m is 0.6 kWh (2,000 BTU) for every 5 °C difference between the water temperature in the pool and the temperature of the soil surrounding the pipe. This increases the operating time by 3% to 5%.

### 3.4 Check-valve installation

Note: If automatic dosing equipment for chlorine and acidity (pH) is used, it is essential to protect the heat pump against excessively high chemical concentrations which may corrode the heat exchanger. For this reason, equipment of this sort must always be fitted in the piping on the **downstream** side of the heat pump, and it is recommended to install a check-valve to prevent reverse flow in the absence of water circulation.

Damage to the heat pump caused by failure to observe this instruction is not covered by the warranty.

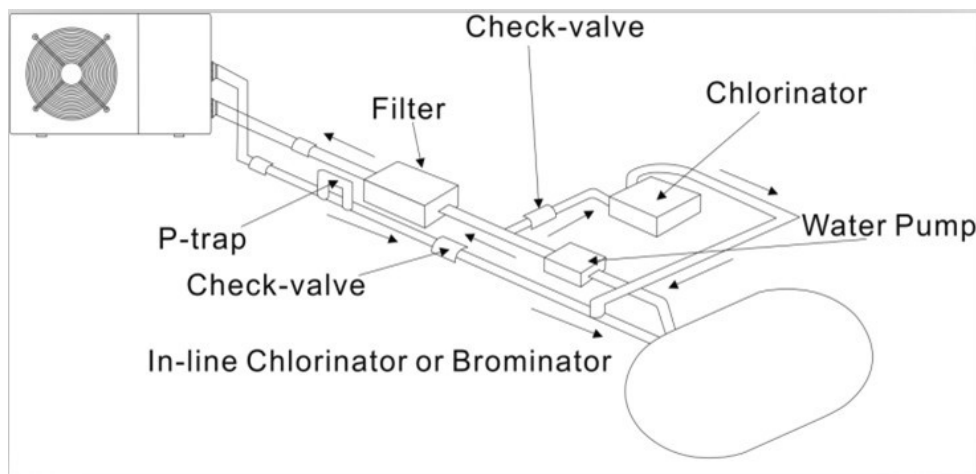

### 3.5 Typical arrangement

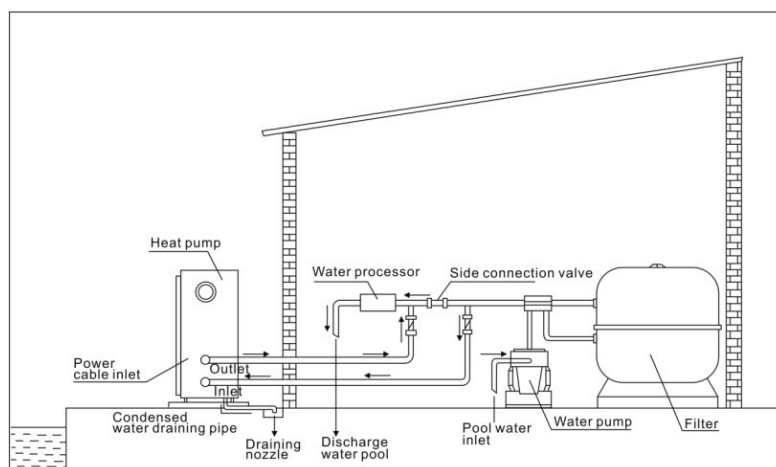

**Note: This arrangement is only an illustrative example.**

### 3.6 Adjusting the bypass

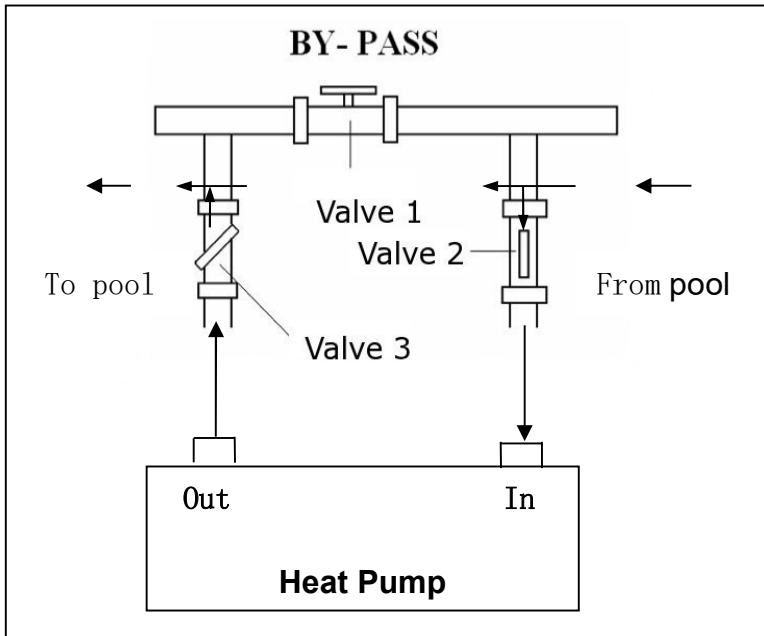

Use the following procedure to adjust the bypass:

- fully open all three valves
- slowly close valve 1 until the water pressure is increased by approximately 100 to 200 g
- Close valve 3 approximately half-way to adjust the gas pressure in the cooling system
- If the display shows error code E03, close valve 1 step by step, to increase water flow and stop when the code disappears.

**Note: Operation without a bypass or with improper bypass adjustment may result in sub-optimal heat pump operation and possibly damage to the heat pump, which renders the warranty null and void.**

### 3.7 Electrical connection

**Note: Although the heat pump is electrically isolated from the rest of the swimming pool system, this only prevents the flow of electrical current to or from the water in the pool. Earthing is still required for protection against short-circuits inside the unit. Always provide a good earth connection.**

Before connecting the unit, verify that the supply voltage matches the operating voltage of the heat pump.

It is recommended to connect the heat pump to a circuit with its own fuse or circuit breaker (slow type; curve D) and to use adequate wiring (see table below).

Connect the electrical wires to the terminal block marked 'POWER SUPPLY'.

A second terminal block marked 'WATER PUMP' is located next to the first one. The filter pump (max. 5 A / 240 V) can be connected to the second terminal block here. This allows the filter pump operation to be controlled by the heat pump.

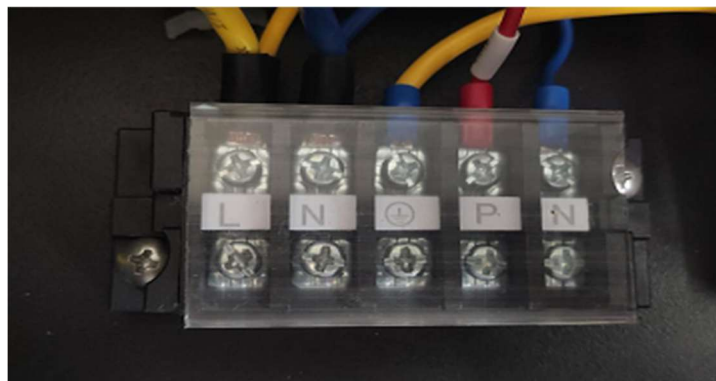

Model	Voltage (V)	Fuse or circuit breaker (A)	Max. current (A)	Wire diameter mm <sup>2</sup> (with max. 15 m length)
NBSPW06	220–240	16	7.2	3*1.5mm <sup>2</sup>
NBSPW09	220–240	16	11.1	3*2.5mm <sup>2</sup>
NBSPW12	220–240	25	14.0	3*2.5mm <sup>2</sup>
NBSPW16	220–240	25	16.0	3*2.5mm <sup>2</sup>
NBSPW20	220–240	32	20.2	3* 4 mm <sup>2</sup>
NBSPW24	220–240	32	25.2	3* 4 mm <sup>2</sup>
NBSPW29	220–240	40	29.7	3* 6 mm <sup>2</sup>
NBSPW33	220–240	40	31.8	3* 6 mm <sup>2</sup>
NBSPW24T	370–390	16	9.8	5*2.5mm <sup>2</sup>
NBSPW29T	370–390	16	11.6	5*2.5mm <sup>2</sup>
NBSPW33T	370–390	20	12.5	5* 4 mm <sup>2</sup>

### 3.8 Initial operation

**Note: In order to heat the water in the pool (or hot tub), the filter pump must be running to cause the water to circulate through the heat pump. The heat pump will not start up if the water is not circulating.**

After all connections have been made and checked, carry out the following procedure:

1. Switch on the filter pump. Check for leaks and verify that water is flowing from and to the swimming pool.
2. Connect power to the heat pump and press the On/Off button  on the electronic control panel. The unit will start up after the time delay expires (see below).
3. After a few minutes, check whether the air blowing out of the unit is cooler.
4. When you turn off the filter pump, the unit should also turn off automatically, if not adjust the flow switch.
5. Allow the heat pump and the filter pump to run 24 hours a day until the desired water temperature is reached. The heat pump will stop running at this point. After this, it will restart automatically (as long as the filter pump is running) whenever the swimming pool water temperature drops 2 degrees below the set temperature.

Depending on the initial temperature of the water in the swimming pool and the air temperature, it may take several days to heat the water to the desired temperature. A good swimming pool cover can dramatically reduce the required length of time.

#### **Water Flow Switch:**

It is equipped with a flow switch to prevent the heat pump of running with inadequate water

flow rate. It will turn on when the pool pump runs and shuts off when the pump shuts off. If the pool water level is more than 1m above or below the heat pump's automatic adjustment knob, your dealer may need to adjust its initial startup.

**Time delay** - The heat pump has a built-in 3-minute start-up delay to protect the circuitry and avoid excessive contact wear. The unit will restart automatically after this time delay expires. Even a brief power interruption will trigger this time delay and prevent the unit from restarting immediately. Additional power interruptions during this delay period do not affect the 3-minute duration of the delay.

### 3.9 Condensation

The air drawn into the heat pump is strongly cooled by the operation of the heat pump for heating the pool water, which may cause condensation on the fins of the evaporator. The amount of condensation may be as much as several liters per hour at high relative humidity. This is sometimes mistakenly regarded as a water leak.

## 4. Accessories

### Accessories Installation

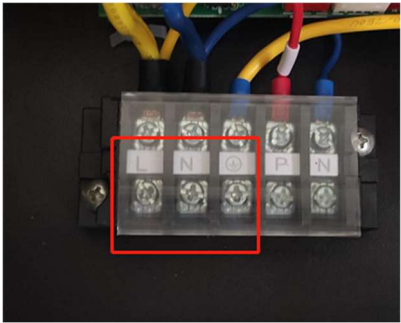
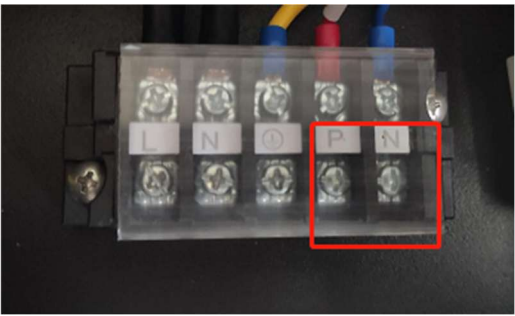
	<p><b>Cable wiring</b></p> <ol style="list-style-type: none"> <li>1. Open the lid of the electrical.</li> <li>2. Secure the wire to the terminal block(LN part).</li> </ol>
	<p><b>Water pump wiring</b></p> <ol style="list-style-type: none"> <li>1. Open the lid of the electrical.</li> <li>2. Secure the wire to the terminal block (PN part)</li> </ol>

## 5. Electrical Wiring

### 5.1 Single phase system (NBSPW06, NBSPW09, NBSPW12, NBSPW16)



## 5.2 Single phase system (NBSPW20)

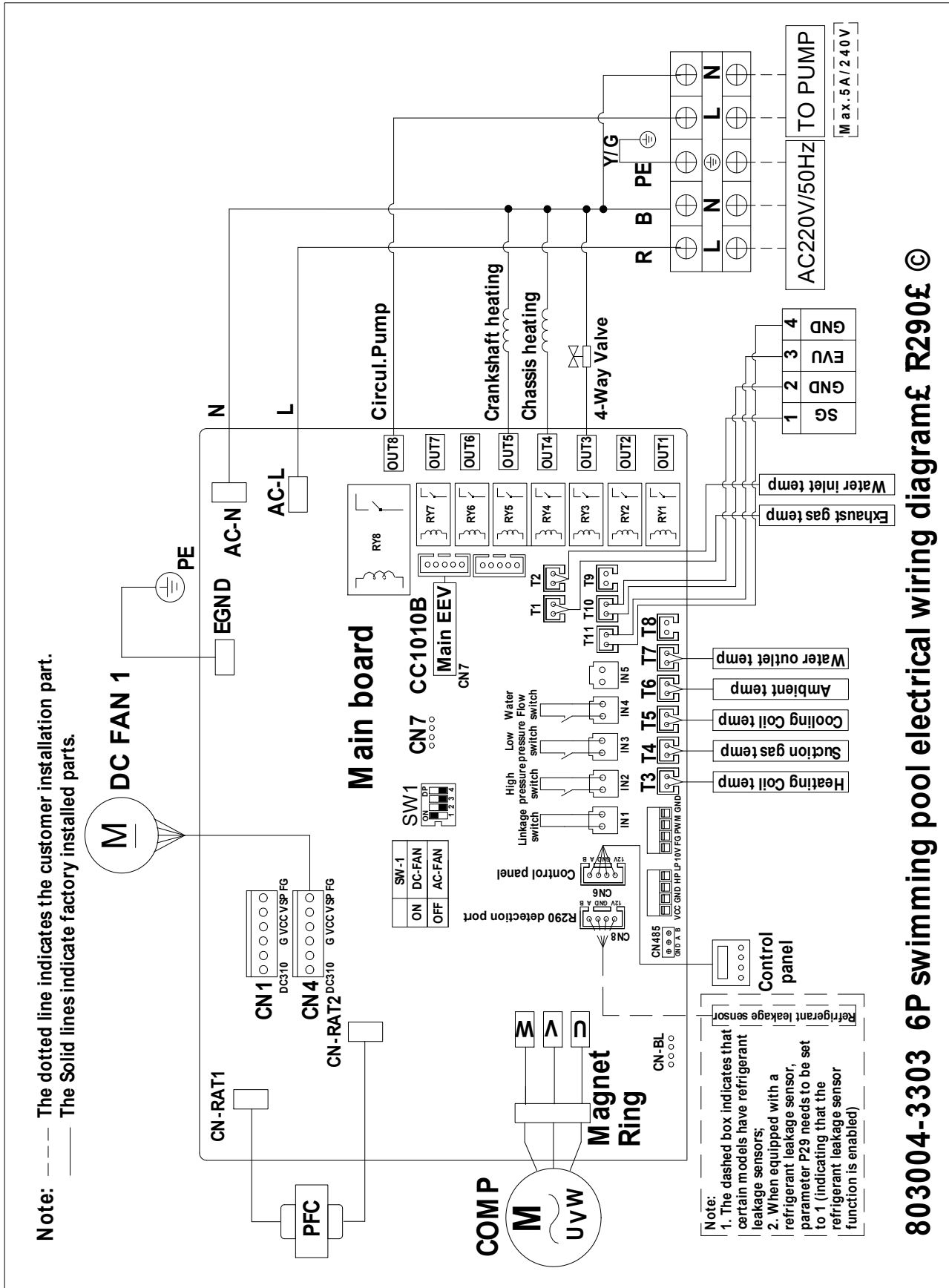

803004-3303 6P swimming pool electrical wiring diagram £ R290£ ©

### 5.3 Single phase system (NBSPW24, NBSPW29, NBSPW33)

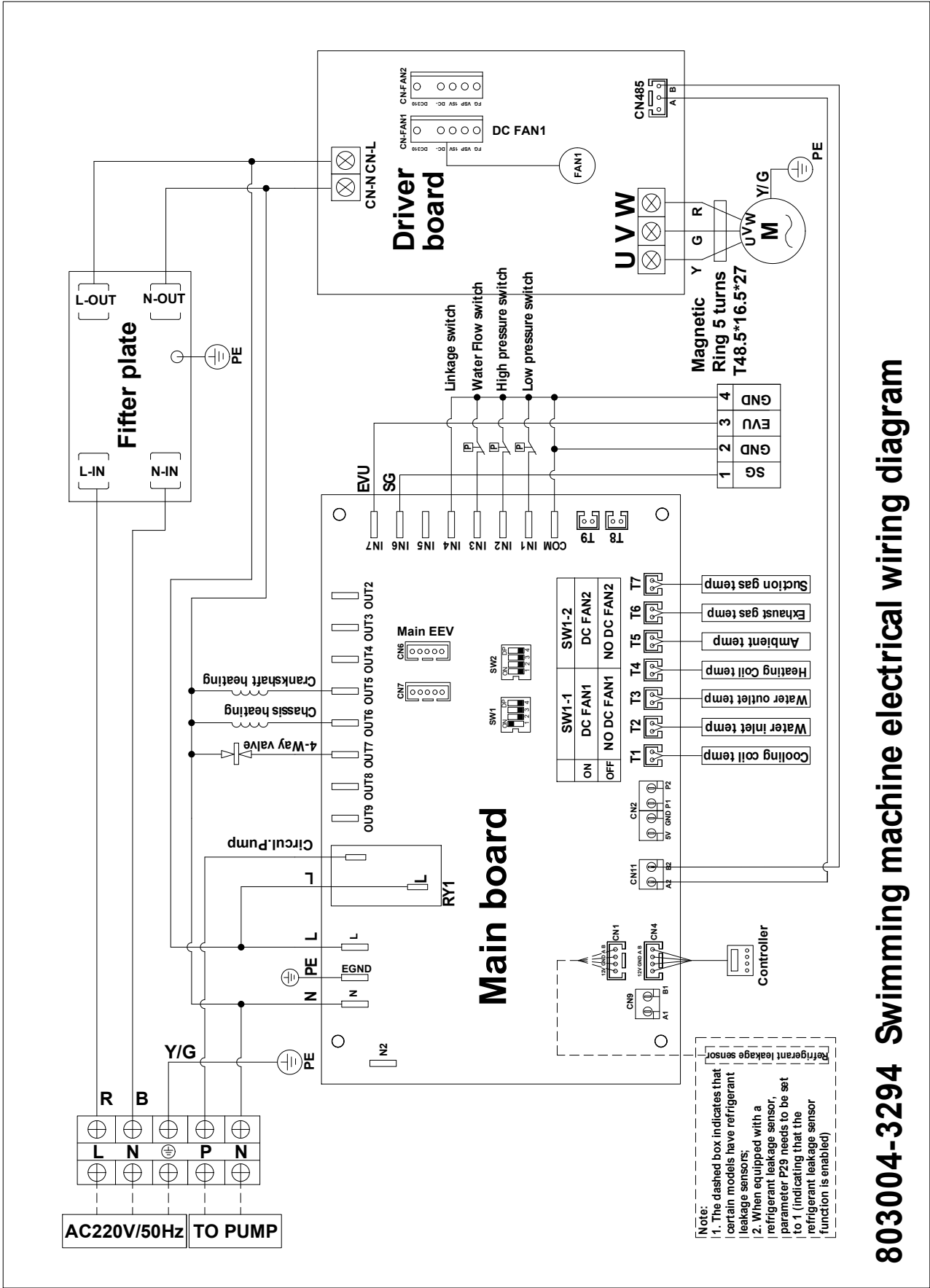

**803004-3294 Swimming machine electrical wiring diagram**

## 5.4 Three phase system (NBSPW24(T), NBSPW29(T), NBSPW33(T))

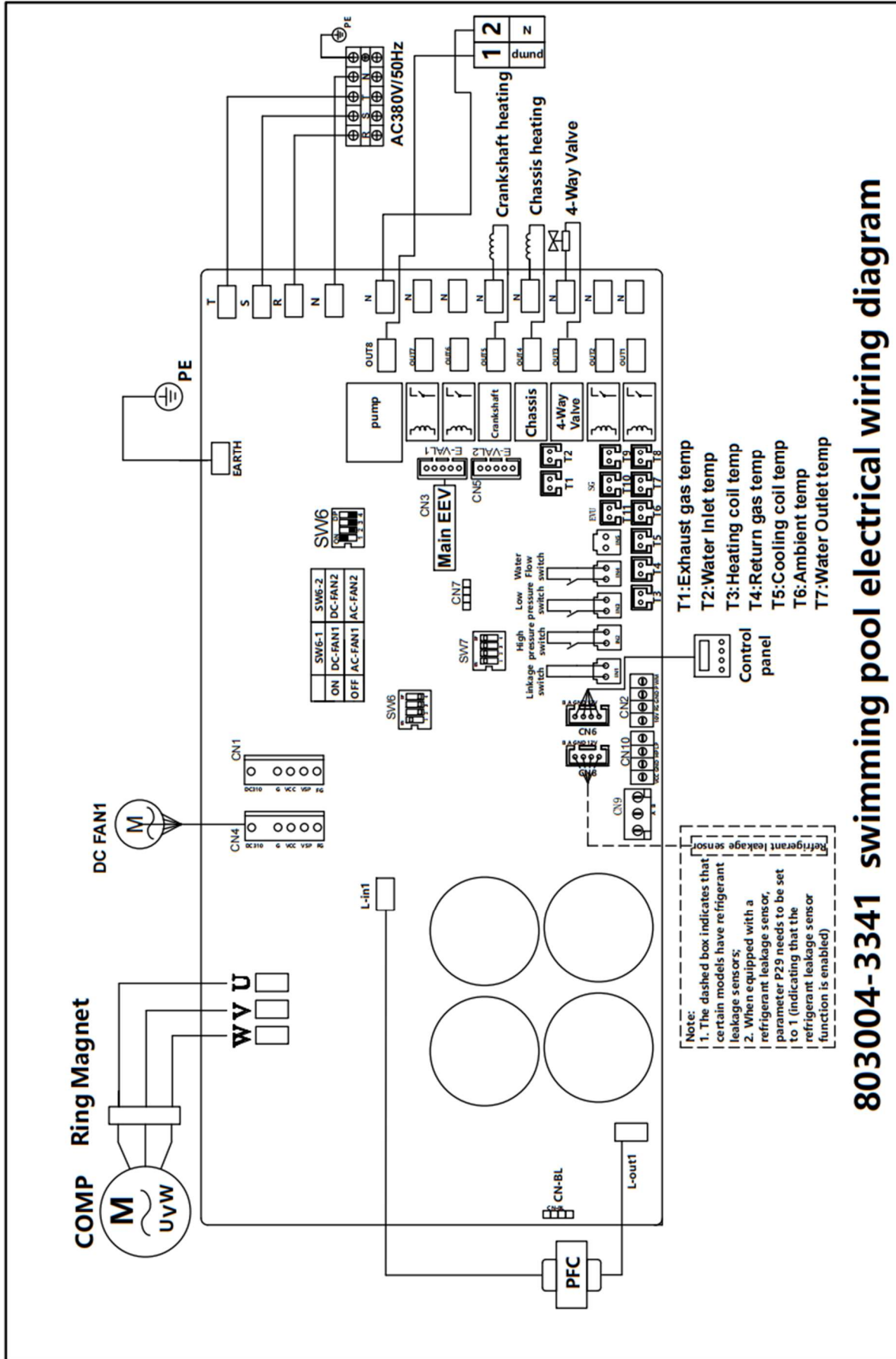

**803004-3341 swimming pool electrical wiring diagram**

**NOTE:**

(1)The above electrical wiring diagrams are only for your reference, please subject the heat pump to the posted wiring diagram.

(2)The swimming pool heat pump must be earthed well, although the unit heat exchanger is electrically isolated from the rest of the unit. Earthing the unit is still required to protect you against short circuits inside the unit. Bonding is also required.

**Disconnect:** A disconnect (circuit breaker, fused or un-fused switch) should be located within sight of and easily accessible from the unit .This is common practice on commercial and residential heat pumps. It prevents remotely-energizing unattended equipment and permits turning off power to the unit while the unit is being serviced.

## 6. Display Controller Operation

### LED Display Controller

#### 6.1 Overview

- ◎ The controller is specially designed for the swimming pool heat pump series, with features as below:
  - Heating and cooling mode;
  - Could show and change the running and setting parameters of the system, easy for user to install and test.
  - With automatic protection and fault warning function;
  - With strong system protection function, like compressor delay protection, high pressure, low pressure, sensor protection, water flow detect etc;
  - The communication distance between the heat pump unit and remote controller shouldn't be less than 100 meters. Communication port is 485 communication.
  - Strong anti-interference, stable performance.

#### 6.2 Basic Model of System Control Chart

- ◎ System Chart

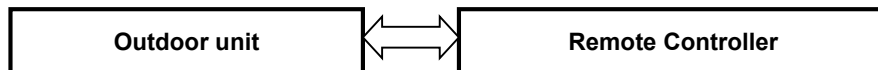





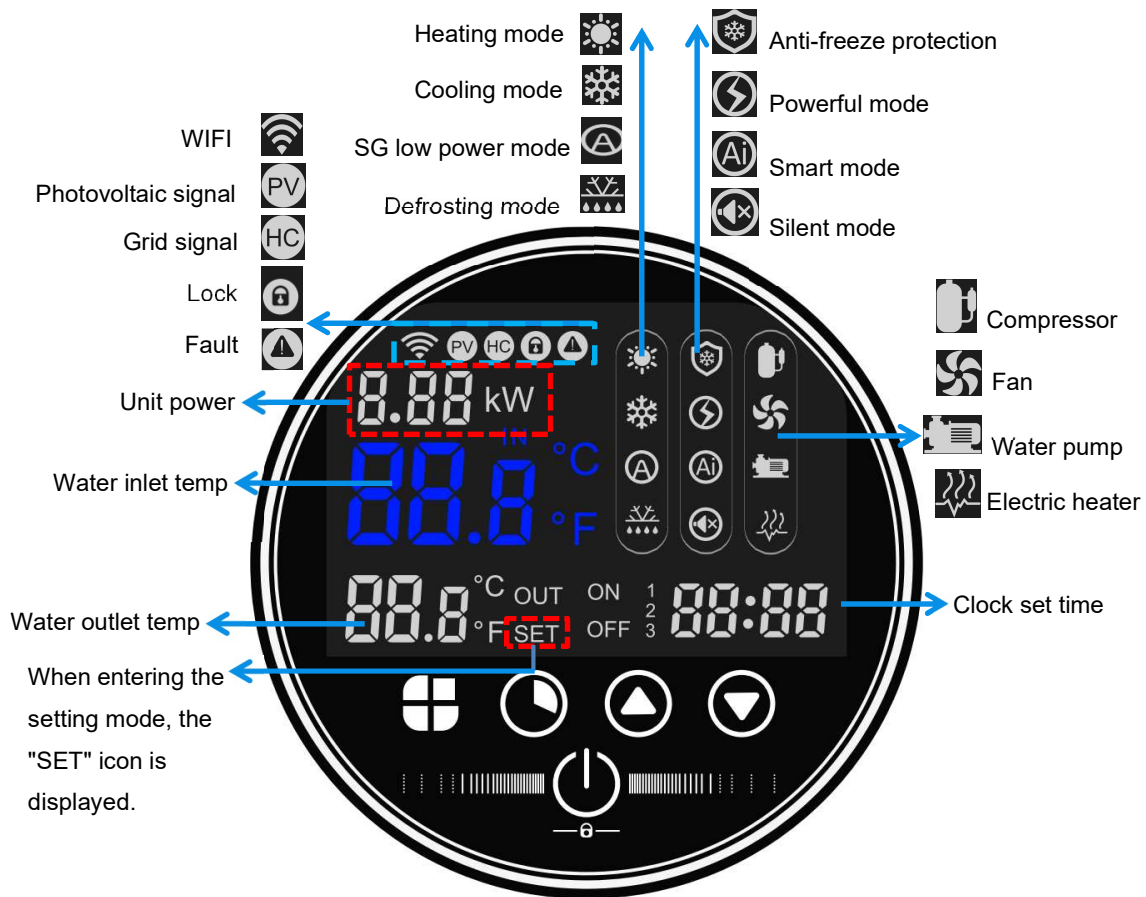



- ◎ Control Principle
  - The Outdoor unit is run according to the remote controller's order
  - The remote controller could change the running parameters and send the running parameters to the outdoor unit
  - The outdoor unit could detect the running condition and send the info or fault to the remote controller









### 6.3 Remote Controller (LCD Wire controller (with WIFI))



















- 1) After power-on, the full screen will display for 3 seconds and then enter normal working state;
- 2) When the machine is turned off : the main interface displays " Water Inlet temp ", " Water Outlet temp ", and " Clock " items;
- 3) When the machine is turned on : the main interface displays " Power ", " Water Inlet temp", " Water Outlet temp", "Pump", "Fan", "Compressor", "Working Mode", " Frequency Mode", " Clock ", and "Timing Status" items;

#### Icon meaning

Icon	Meaning	Icon	Meaning
	Heating mode		Cooling mode
	Fault		Defrosting mode
	Anti-freeze protection		Powerful Mode
	Standard Mode		Silent Mode



	Compressor		Fan
	Water Pump		Electric heater
	WIFI		Photovoltaic signal (EVU)
	Grid signal (SG)		Lock screen
	Clock		

## 6.4 Key Operation

Button	Name	Function
	Power button	<ul style="list-style-type: none"> <li>➤ Long press "  " for 3 seconds to switch on/off;</li> <li>➤ In other interfaces, short press "  " to return to the main interface;</li> </ul>
	Up key	<ul style="list-style-type: none"> <li>➤ When the machine is turned on, in the main interface, press "  " to set the temperature in the current mode;</li> </ul>
	Down key	<ul style="list-style-type: none"> <li>➤ When the machine is turned on, in the main interface, press "  " to set the temperature in the current mode;</li> </ul>
	Clock key	<ul style="list-style-type: none"> <li>➤ In the power on/off state, short press "  " to set the clock , and combine "  " and "  " to set the clock ;</li> <li>➤ In the power on/off state, long press "  " to set the timer , and combine "  " and "  " to set the timer ;</li> </ul>
	Query Key	<ul style="list-style-type: none"> <li>➤ When the machine is turned on, long press "  " to switch modes;</li> </ul>









## 6.5 Parameter query and setting

### 6.5.1 User parameter query

In the power on/off state, directly press the "" key on the main interface to enter the parameter query state. At this time, press "", "" to query the parameters of A01-A16 , as follows ;

Code	Name	Scope	Display value
A01	Inlet water temperature	- 30~99°C	Measured value
A02	Outlet water temperature	- 30~99°C	Measured value
A03	Ambient temperature	- 30~99°C	Measured value
A04	Exhaust gas temperature	0~125°C	Measured value
A05	Return gas temperature	- 30~99°C	Measured value
A06	External coil temperature	- 30~99°C	Measured value
A07	Inner coil temperature	- 30~99°C	Measured value
A08	Main expansion valve opening	0 ~ 480	
A09	Enthalpy increase expansion valve opening	0 ~ 480	
A10	Compressor current		
A11	Heat sink temperature		
A12	DC bus voltage value		
A13	Actual speed of press		
A14	DC fan 1 speed		When there is a single fan, it is displayed here. When there are two fans, it is the speed of fan 1
A15	DC fan 2 speed		When there is a single fan, it is displayed as 0. When there are two fans, it is the speed of fan 2
A16	Refrigerant gas concentration	0 ~ 100%	
A17	Low pressure value		
A18	Low pressure conversion temperature		

### 6.5.2 Parameter query and setting : (can be set on or off, password: 0814)

In the power on/off state, you can simultaneously press and hold the "  " + "  " keys for 3 seconds to enter the password input state. At this time, the tens digit "0" of the hour in  the clock area flashes. At this time , short press the "  " key to shift the position. The ones digit of the hour digit flashes. Combine "  " and "  " to input "8", and then press the "  " key again . The tens digit of the minute digit flashes and input "1". Press the "  " key again . The ones digit of the minute digit flashes and input "4". After the password is entered correctly, press the "  " key again to confirm the password and enter the engineering parameter query interface (if the password is incorrect, it will return to the main interface);

Code	Parameter	Scope	Default value
P1	Temperature difference	1~18°C	1°C
P2	Cooling set temperature	8°C~35°C	27°C
P3	Heating set temperature	5°C~40°C	27°C
P4	Inlet water temperature compensation	-5°C~15°C	0°C
P5	Defrost cycle	20~90MIN	45MIN
P6	Defrost entry temperature	-9°C~-1°C	-3°C
P7	Defrost time	5~20MIN	8MIN
P8	Defrost exit temperature	1°C~40°C	20°C
P9	Defrost environment and coil temperature difference	0°C~15°C	9 °C
P10	Ambient temperature for defrosting	0°C~20°C	17°C
P27	Smart grid function	0:Disable 1:Enable	0
P29	R290 refrigerant leakage sensor function	0:Disable 1:Enable	1

### 6.6 Clock Settings

Clock settings: (can be set power on or off)

short pressing the "🌙" key, the clock will be set. The hour will flash first, indicating that the hour value of the current time can be adjusted by the "⬆️" and "⬇️" keys. Each time the "⬆️" key is pressed, the hour will increase by one, and each time the "⬇️" key is pressed, the hour will decrease by one. If the "⬆️" key or "⬇️" key is pressed for a long time, the hour will increase or decrease automatically. After setting the hour value, press the "🌙" key again; the minute value will flash at this time, indicating that the minute value of the current time can be adjusted by the "⬆️" and "⬇️" keys. After setting the minute value, press the "🌙" key again to end.

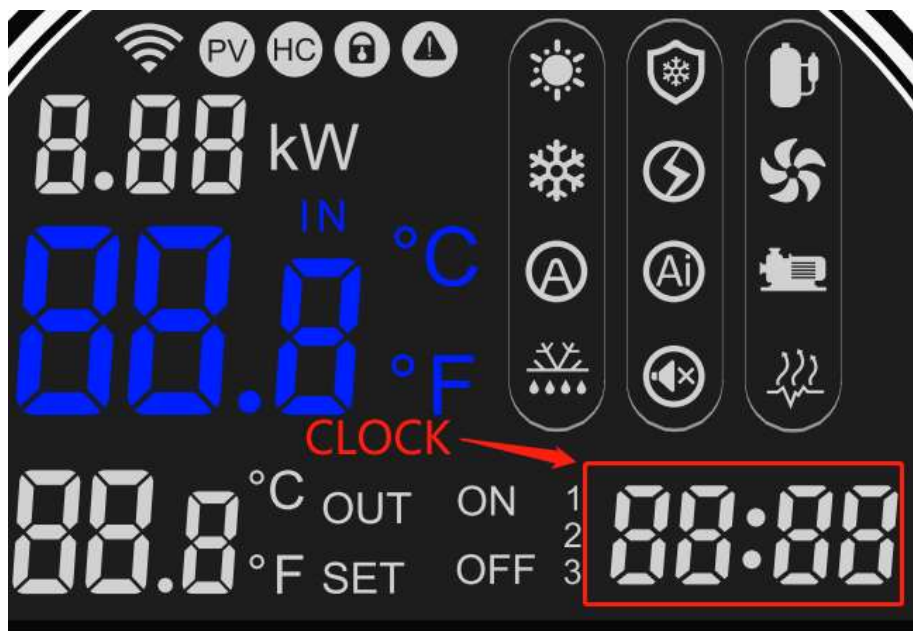

Note: If there is no operation on the controller for 10 seconds, the set time will be automatically saved and the main interface will be returned.

### 6.7 Timer power on/off settings

Press and hold the "🌙" button for 3 seconds to enter the timer setting:

Enter the timing selection, then the "ON 1" clock "hour" flashes, and you can set the hour by pressing "⬆️" and "⬇️". Press the "🌙" key again to switch to the clock "minute", and you can set the minute by pressing the "⬆️" and "⬇️" keys.



Press the "🌙" key again to switch to the " OFF 1 " setting: the clock " hour " flashes, and you can set the hour by using the "⬆️" and "⬇️" keys; press the "🌙" key again to switch to the clock " minute " and you can set the minute by using the "⬆️" and "⬇️" keys ;



The settings for other time periods are similar.

Press "🔌" to exit or confirm.

Press on the main interface to display the number of currently set timing periods;

To cancel the timer setting:

When the set power-on time and power-off time are the same, the timing setting for the current time period is canceled .



### 6.8 Smart Grid (SG-Ready)

When the smart grid function (parameter P27 ) is enabled, the heat pump starts to run the smart grid function.



SMART GRID				
Mode	ECU	SG	Running status	
Working Mode 1	ON	OFF	Force shutdown	Heat pump forced to shut down compressor and fan (Low power mode, icon 🌙 flashing)
Working Mode 2	OFF	OFF	Normal operation	Heat pump working properly
Working Mode 3	OFF	ON	Enhanced Mode	Heat pump running in powerful mode
Working Mode 4	ON	ON	Forced to open	Heat pump running in powerful mode

## 6.9 Key Operation



### 6.9.1 Locking and unlocking keys

Press the "" + "" keys simultaneously for 3 seconds to enter the lock screen state, and press them simultaneously for 3 seconds again to exit the state;





### 6.9.2 Forced defrosting

- 1) Press and hold the "" and "" keys at the same time to enter the forced defrost mode;
- 2) When entering defrost mode, "" is displayed.

### 6.9.3 Temperature unit switching (can be set when on or off)

In the power-off state, on the main interface, press and hold "" and "" for 3 seconds to switch between Celsius and Fahrenheit.



### 6.9.4 No operation screen off function (can be set when on or off)

- 1) The factory default setting of the remote controller is "no operation, no screen off";
- 2) Press and hold the "" + "" keys for 5 seconds at the same time to enter the three-minute inactivity screen off function;
- 3) Press and hold the "" + "" keys for 5 seconds again to exit the three-minute inactivity screen off function, and repeat this cycle;





### 6.9.5 Manual electric heating function

On the main interface, press and hold "" for 3 seconds to manually turn on/off the electric heating function.

### 6.9.6 Forced Exit Preheating

When the system power down time meets the conditions, the system enters the preheating state. At this time, the compressor icon "" flashes to indicate that it has entered the preheating state. During the system preheating process, you can use the wired controller to press and hold the "" and "" keys simultaneously to force the system to exit this preheating.

### 6.9.7 Restoring parameters to factory settings

In the off state, press and hold the “” key + “” key + “” key + “” key for 3 seconds to restore the factory settings. The buzzer will sound twice in succession and all parameter values will return to the default values.

## 7. Troubleshooting

### 7.1 Faults and Solutions

- ⦿ If there's error in the heat pumps, the error code and error definition will be displayed in the main interface, and saved the record in FAULTY column inside the SETTING interface.
- ⦿ The following Common Error Codes will be displayed on the controller panel:

Error Code	name	description	Solution suggestion
Er 03	Water flow protection	The water flow in the pipeline decreases or there is a lack of water. Water flow switch damaged	Check water flow Replace the water flow switch
Er 04	System antifreeze	The unit detected antifreeze conditions	-
Er 05	High pressure protection	The throttling device is too small or blocked. The condenser fins are dirty or blocked by debris. Insufficient condensing air volume or fan failure Overcharge of refrigerant	Check the throttling device Cleaning the condenser fins Check whether the fan is abnormal Recharge refrigerant
Er 06	Low pressure protection	Evaporator fins are dirty and clogged Refrigerant leakage Low voltage switch failure	Cleaning the evaporator fins Find the leak point, weld it, and then refill the refrigerant. Check the low pressure switch and replace it if it is faulty
Er 09	Communication failure	Mainboard or wire controller damaged	Replace the main board or wire controller

		The communication line is in poor contact or damaged.	Reconnect the communication line between the mainboard and the wire controller Replace the communication line
Er 10	Frequency conversion module communication failure (alarm when the communication between the external board and the drive board is disconnected)	-	-
Er 21	Ambient temperature sensor failure	No system downtime	Check whether the probe is connected properly; Check whether the temperature probe is normal;
Er 16	External coil temperature failure		
Er 42	Internal coil temperature failure		
Er 29	Return gas temperature failure		
Er 15	Inlet water temperature failure	System downtime	Check whether the temperature probe is normal;
Er 27	Outlet water temperature failure		
Er 18	Exhaust gas temperature failure		
Er 12	Exhaust gas temperature too high protection	Low refrigerant, leakage System dirty and blocked Insufficient refrigerant oil in the compressor Exhaust probe resistance offset	Recharge refrigerant Replace the filter Refill compressor refrigeration oil Replace the exhaust probe
Er 23	Cooling water outlet temperature too low protection	The water flow in the pipeline decreases	Check water flow Replace the outlet water temperature probe
Er 32	Heating water outlet temperature too high protection	Temperature sensor resistance drift	
Er 19	DC fan failure	If the DC fan stalls or has no feedback for 15 seconds, a DC fan fault is reported.	Check whether the DC fan wiring is normal
Er 74	Refrigerant sensor failure	Not "0" If no communication is detected for 1 minute, a refrigerant sensor failure is reported	Check whether the R290 sensor wiring is normal
Er 75	Refrigerant leakage protection	If the R290 concentration > R40 [R290 concentration is too high] (default 15%), then "R290 leakage fault" will be reported.	Check for refrigerant leaks Repair refrigerant leaks

			This fault will not be automatically restored unless the power is off.
--	--	--	--

The E20 fault will display the following fault numbers at the same time, and the fault code will switch every 3 seconds; faults 1 to 128 will be displayed first.

Faults 257 to 384 will be displayed only when faults 1 to 128 do not occur. If two or more faults of the same priority level occur at the same time,

For example, if faults No. 16 and No. 32 occur at the same time, 48 will be displayed.

<b>Error Code</b>	<b>name</b>	<b>description</b>	<b>Solution suggestion</b>
1	IPM Over-current	<ol style="list-style-type: none"> <li>1.The IPM overloaded or overheated</li> <li>2.The U,V,W driver short-circuited</li> <li>3.The IPM module fault</li> <li>4.The compressor damaged</li> </ol>	<ol style="list-style-type: none"> <li>1.Ensure that the ring temperature, water temperature, water flow, etc. are within the operating range of the unit;</li> <li>2.Use a multimeter to measure the motor U,V,W in ohmic gear to ensure no short circuit</li> <li>3.Replace the frequency conversion module</li> <li>4. Replace the compressor</li> </ol>
2	compressor synchronous abnormal	<ol style="list-style-type: none"> <li>1. The compressor overloaded instantaneously</li> <li>2. The compressor does not match the program</li> <li>3. The difference between high and low pressure starts the compressor excessively</li> </ol>	<ol style="list-style-type: none"> <li>1 Ensure that the ring temperature, water temperature, water flow, etc. are within the operating range of the unit;</li> <li>2. Replace the driver board with the correct program</li> <li>3. Ensure that the high and low pressure difference starts normally</li> </ol>
8	compressor output phase absent	<ol style="list-style-type: none"> <li>1. The U, V, and W cables of the compressor are missing or improperly connected</li> <li>2. The compressor does not match the program</li> <li>3. The difference between high and low pressure starts the compressor excessively</li> </ol>	<ol style="list-style-type: none"> <li>1. Check whether the U, V, and W wires of the compressor are missing or in poor contact</li> <li>2. Update the driver</li> <li>3. Ensure that the high and low pressure difference starts normally</li> </ol>
16	DC bus low voltage	<ol style="list-style-type: none"> <li>1. The power supply unstable</li> <li>2.AC suddenly power off, the inverter capacitor residual power supply chip detects that the DC voltage will be too low</li> <li>3. The PFC module fault</li> </ol>	<ol style="list-style-type: none"> <li>1. Ensure that the power supply is stable</li> <li>2. Check the capacitor after it is powered off</li> <li>3. Replace the faulty frequency conversion module</li> </ol>
32	DC bus high voltage	<ol style="list-style-type: none"> <li>1. The power supply voltage too high.</li> <li>2. The capacitor fault</li> <li>3. The PFC module fault</li> </ol>	<ol style="list-style-type: none"> <li>1. Ensure that the power supply voltage is normal</li> <li>2. Replace the capacitor</li> <li>3. Replace the faulty frequency conversion module</li> </ol>

64	Radiator over temperature	<ol style="list-style-type: none"> <li>1. The fan on the host is faulty</li> <li>2. The air duct is blocked</li> </ol>	<ol style="list-style-type: none"> <li>1. Check and replace the fan</li> <li>2. Ensure proper ventilation</li> </ol>
128	Radiator temperature error	<ol style="list-style-type: none"> <li>1. The heat sink sensor is short-circuited or open</li> <li>2. Heat sink fouling</li> <li>3. The ambient temperature too high</li> </ol>	<ol style="list-style-type: none"> <li>1. Replace the frequency conversion module</li> <li>2. Remove dust and scale from the heat sink</li> <li>3. Lower the ambient temperature</li> </ol>
257	communication failure	<ol style="list-style-type: none"> <li>1. The connector of the communication cable between the main board and the driver board is in poor contact or falls off</li> <li>2. Internal components of the heat pump damaged</li> <li>3. The output voltage of the power supply board in the module abnormal or no output</li> </ol>	<ol style="list-style-type: none"> <li>1. Reconnect and ensure stability</li> <li>2. Replace the internal components</li> <li>3. Replace the power module</li> </ol>
258	AC Input phase absent	Input phase absent (Three phase module is effective)	Inspection input circuit
260	AC Input over-current	Input three phase imbalance (three phase module is effective)	Inspection input three phase phase voltage
264	AC Input low voltage	<ol style="list-style-type: none"> <li>1.The input voltage too low</li> <li>2.The current transformer damaged during transportation</li> </ol>	<ol style="list-style-type: none"> <li>1.Ensure that the input voltage is normal</li> <li>2.Ensure that the current transformer works properly</li> </ol>
288	IPM too high temperature	<ol style="list-style-type: none"> <li>1.The fan is faulty or the air duct blocked</li> <li>2.The ring temperature rises too fast, resulting in over-temperature drop too late to react</li> <li>3.The power supply voltage and current too high or too low</li> </ol>	<ol style="list-style-type: none"> <li>1. Replace the fan</li> <li>2.Ensure that the air duct unblocked</li> <li>3. Reduce the ring temperature</li> <li>4. Ensure that the power supply voltage and current are normal</li> </ol>
320	Compressor peak current too high	<ol style="list-style-type: none"> <li>1. Compressor load is too large;</li> <li>2. The driver board is faulty</li> <li>3. The compressor is damaged</li> </ol>	<ol style="list-style-type: none"> <li>1.Ensure that the ring temperature, water temperature, water flow, etc. are within the operating range of the unit;</li> <li>2.Replace the compressor driver plate.</li> <li>3. Replace the compressor</li> </ol>

384	PFC module over-temperature protection (only for old 2.0kw and 4.5kw boards)	<ol style="list-style-type: none"> <li>1. Poor heat dissipation, condensing fan speed is too low or stops running unexpectedly</li> <li>2. The ambient temperature rises too quickly, causing overtemperature and frequency reduction to fail to react in time</li> </ol>	<ol style="list-style-type: none"> <li>1. Replace the fan</li> <li>2. Ensure that the air duct unblocked</li> <li>3. Reduce the ring temperature</li> <li>4. Ensure that the power supply voltage and current are normal</li> </ol>
-----	--	---	---

## **7.2 Common Faults and Debugging**

©The user must hire the professional maintenance staff to fix if the unit has any problems during working. The maintenance staff might refer to the chart to debug.

<b>Error Code</b>	<b>Error Status</b>	<b>Possible reason</b>	<b>Solution</b>
	Heat pump not running	Power fault Wiring loose Fuse blow fused Thermal Overloaded protector off Low pressure too low	Put off the power switch, check the power supply find out the causes and repair Replace the fuse blow test the voltage and current
	Water pump is working but without water cycle or water pump high noise	Lack of water in the system with air in the water system the valves are not all open filter is dirty and blocked	Check the system replenishment device and replenish the system discharge the air in the water system Open the water system valve Clean the water filter
	Low heating capacity	Lack of refrigerant Bad heat preservation of water system; Dry filter Bad heat dissipation of air heat exchanger Not enough water flow	Leakage detection and supply refrigerant Reinforce the heat preservation of water system Change the dry filter Clean the air heat exchanger Clean the water filter
	Compressor not working	Power failure; Contactor of compressor damage; wiring loose Compressor Overheat protection outlet water temp. Too high; Not enough water flow Compressor overload protector tripped	Find out the causes and solve the power failure Change the contactor of compressor Find out the loose point and repair Check the unit pressure and exhaust gas temp. Reset the outlet water temp Clean the water filter and discharge the air in the system Check the running current and whether overload protector damage
	compressor running noise too high	Liquid refrigerant enters the compressor The inner parts of compressor damage Too Low voltage	Check the expansion valve whether out of effect Replace the compressor Check Power Voltage
	Fan not working	The fastening screw of the fan loose Fan motor damage Contactor damage	Reinforce the screw Replace the fan motor Replace the contactor

	Compressor running but heat pump not heating	Refrigerator is all leaking out Compressor fault Compressor reversal	Check leakage and charging the refrigerant Replace the compressor Exchange the order phase of compressor
	Low water flow protection	Not enough water flow in the system Water switch fault	Clean the water filter and discharge the air in the system Check the water switch and replace it

## 8. Maintenance

(1) You should check the water supply system regularly to avoid the air entering the system and occurrence of low water flow, because it would reduce the performance and reliability of the heat pump.

(2) Clean your pools and filtration system regularly to avoid the damage of the unit as a result of a dirty or clogged filter.

(3) You should discharge the water from the bottom of the water pump if the heat pump will stop running for a long time (especially during the winter season).

(4) On any other moment, you should check if the unit has enough water before the unit starts to run again.

(5) After the unit is conditioned for the winter season, it is preferred to cover the heat pump with the special winter heat pump cover.

(6) When the unit is running, there is always a little water discharge under the unit.

## 9. General Operating Guide

### Initial Start-up Precautions

First boot-strap and Running state checks

1. To ensure the same power as the product nameplate required power.
2. Unit electrical connections: Check if power supply wire track and connection is ok; if ground wire is properly connected; Check if water pump and other chain device is properly connected
3. Water pipe and pipe: water pipe and pipe must be washed two and three times, ensure clean and no any pollution.
4. Check water system: If the water is enough and no air, ensure no leakage

5. First boot-strap or starting up again after long time stop, ensure power on ahead and heating at least 12 hours for crankcase (local loop temp. is zero). Water pump start up first, last a while, fan start up, compressor start up, unit regular work.
6. Running checks (according to the following data to check if the unit running is normal)  
After unit normal running, check the following item:
  - a. Input and output water temperature.
  - b. cycle water flow of the side
  - c. running electric current of compressor and fan
  - d. High and low pressure value when heating running.



**CAUTION** — Refrain from using this heat pump if any electrical components have been in contact with water. Immediately call a qualified service technician to inspect the heat pump.



**CAUTION** — Keep all objects clear above the heat pump. Blocking air flow could damage the unit and may void the warranty.

## **Users' Guide**

### **1. Rights and Responsibility**

1.1 To ensure you have the service in guarantee period, only the professional server and technology staff can install and repair the unit. If you infract this request and cause any loss and damage, our company will not be claimed any responsibility.

1.2 After receiving the unit, check if have damage on shipment and all parts are complete; any damage and lack of parts please notice the dealer in written.

### **2. User Guide**

2.1 All safety protection devices are set in unit before leaving factory, don't adjust by yourself.

2.2 Unit have enough refrigerant and lubricating oil, don't fill or replace them; if need fill owing to leak, please refer to the quantity on nameplate (if refill refrigerant, need re-vacuum).

2.3 External water pump must connect with the message of unit, or else easily show various water lack alarm.

2.4 Regular clean water system according to maintenance request.

2.5 Pay attention to antifreeze when the environment temp. is less than zero in winter.

2.6 Safety Precautions

A User can't self-install the unit, ensure agent or specialized install company to do, or else maybe

cause safety accident and affect the use effect.

B When install or use the unit, please check if the power is corresponding with unit power.

C The main power switch of unit should install leakage protector; the power cord must meet unit power request and national standard and local Fire & Safety Regulations.

D Unit must have ground wire; don't use the unit if no ground wire; forbid connect the ground wire to null line or water pump.

E The main power switch of unit should set much higher 1.4 meter (child don't touch it), to prevent child play it and cause danger.

F When unit is soaking, please contact the factory or maintain department, you can use it again after maintenance.

G Forbid insert any tools into fan fence of unit, fan is dangerous. (child special care)

H Don't use the unit if turn off the fan fence.

I To avoid electric shock or cause fire, don't store and use fixtures, oil paint and petrol etc. combustible gas or liquid around the unit; don't throw the water or other liquid on the unit and don't touch the unit by wet hand.

J Don't adjust the switch, valve, controller and internal data except company server or authorized staff.

K If safety protection device often start up, please contact factory or local dealer.

## 10. Owner Inspection

We recommend that inspections on heat pumps are done frequently, especially after abnormal weather conditions. The following basic guidelines are suggested for your inspection:

1. Make sure the front of the unit is accessible for future service.
2. Keep the top and surrounding areas of the heat pump clear of all debris.
3. Keep all plants and shrubs trimmed and away from the heat pump especially the area above the fan.
4. Keep lawn sprinklers from spraying on the heat pump to prevent corrosion and damage.
5. Ensure that the ground wire is always properly connected.
6. The filter must be maintained on a regular basis in order to ensure clean and healthy water to protect the heat pump from damage.
7. Keep inspecting power and electrical components' wiring to make sure their normal operation.
8. All the safety protection devices have been set up; please refrain from changing these settings. If any changes are needed, please contact the authorized installer/agent.
9. If the heat pump is installed under roof without a gutter, ensure that all measures are taken to prevent excessive water from flooding the unit.
10. Do not use this heat pump if any electrical part has been in contact with water. Contact an authorized installer/agent.
11. If the increase of power consumption is not due to colder weather, please consult with the local authorized installer/agent.

12. Please turn off the heat pump and disconnect it from the mains power supply, when not in use for a prolonged period of time.

## 11. WiFi connection and configuration

### 11.1 APP Download



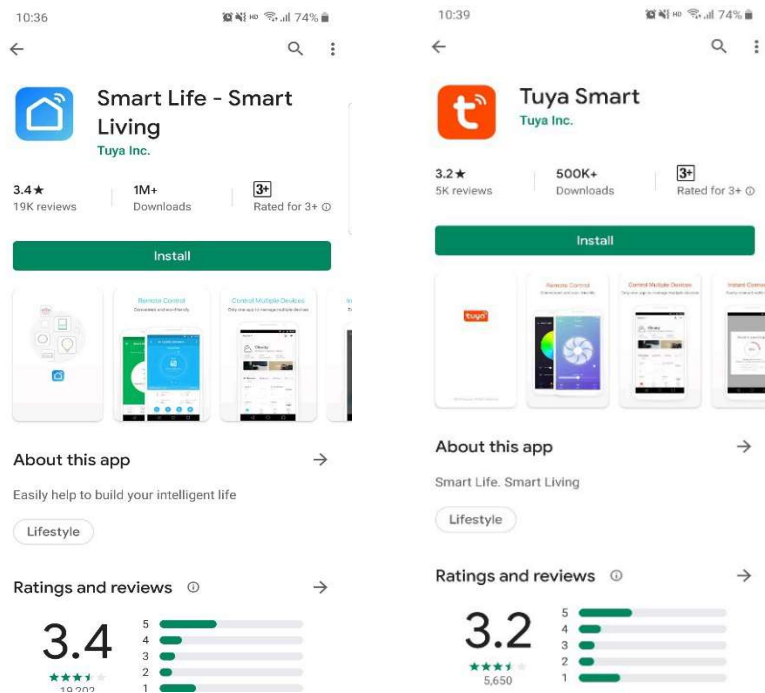

1) In the Google Play Store or Apple App Store, search for Smart Life and then download and install it  ;



### 11.2 WIFI network configuration steps

1) Step 1:

Solution 1: When powering on, the interface of the wire controller will flash "" to enter the intelligent network connection. At this time, the network can be carried out. If there has been no pairing, the network will be exited and the intelligent network connection mode needs to be entered manually:

Press and hold the "" and "" keys for 5 seconds to enter the pairing state. The "" icon in the upper left corner flashes quickly. After successful pairing, the icon stays on. If pairing is unsuccessful or has not been paired, the icon will not be displayed after 3 minutes, and the network configuration state will be exited. The "" icon stops flashing, and the WIFI

module will no longer be paired. To re-pair, press and hold the "⌘" and "⏻" keys for 5 seconds;

Solution 2: Press and hold the "⏻" and "⏮" keys for 3 seconds to enter the "Compatibility Mode" network configuration. The "📶" icon flashes slowly when entering.

2) Step 2: Turn on the Bluetooth and WIFI functions of your phone and connect to the WIFI hotspot. The WIFI hotspot must be able to connect to the Internet normally, as shown in the figure: Connect to the WIFI hotspot "pwwm";

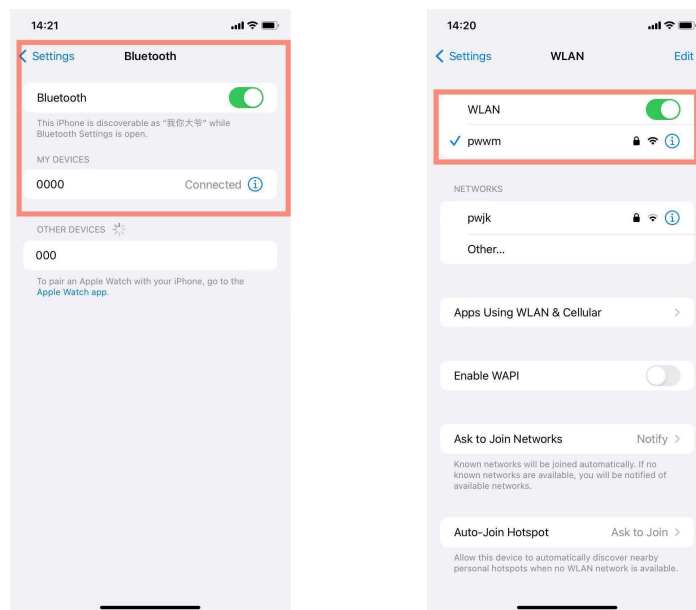

3)Step 3:

Add device solution 1:

Open the "Smart Life" APP, log in to the main interface, click "Add Device" and select " Add " → enter WiFi information → Complete;

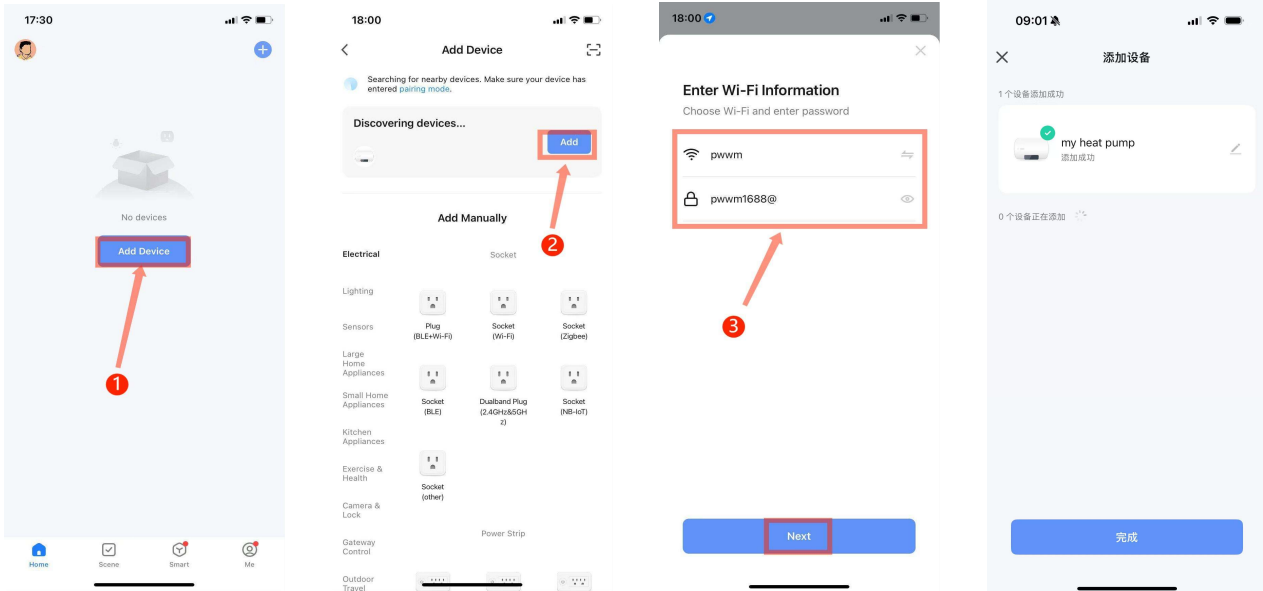

### Add device solution 2:

Open the "Smart Life" APP, log in to the main interface, click "+" in the upper right corner, enter the device type selection, select " Large Appliances " → Select " Water Heater " →

Enter WiFi information → Complete ;

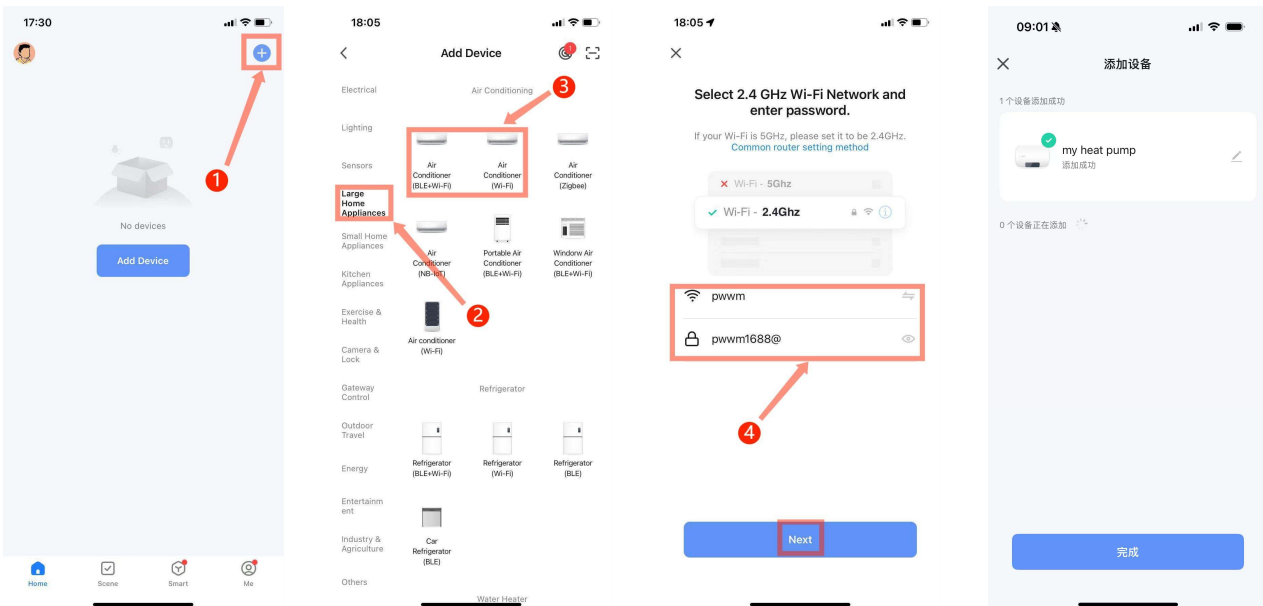

### 11.3 Functional Operation

1) After the device is successfully bound, click on the "my heat pump" (device name, editable) operation page on the "Smart Life" main interface.

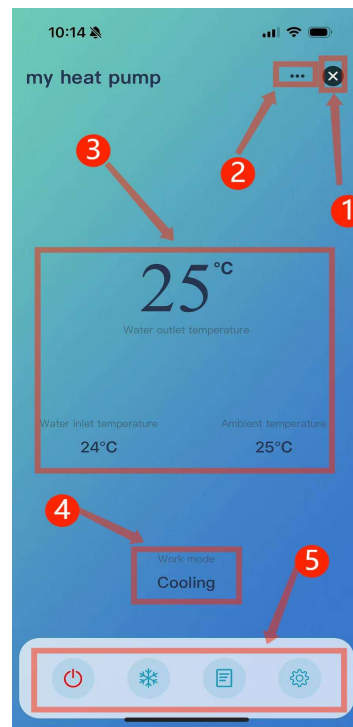
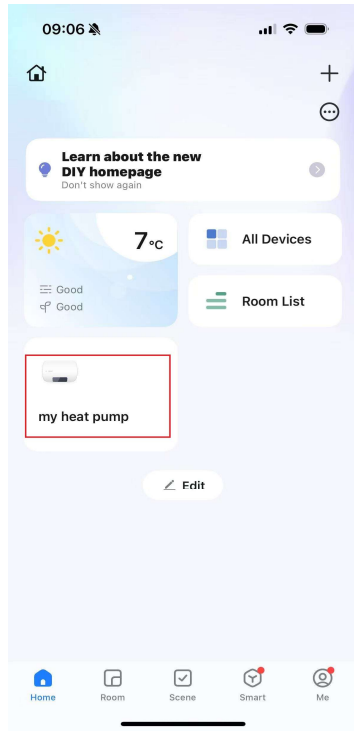

①-Return: Return to the main page;

②-More: You can change the device name, select the device installation location, check the network status, add shared users, create a device group, view device information, etc.;

③-Temperature: water outlet temperature, water inlet temperature, ambient temperature;

④-Current mode;

⑤-Power on/off settings, operation mode, parameter status, settings

2) Modify the device name:

Click " More " in the order shown below to enter "Device Details" and click "Device Name" to rename the device.

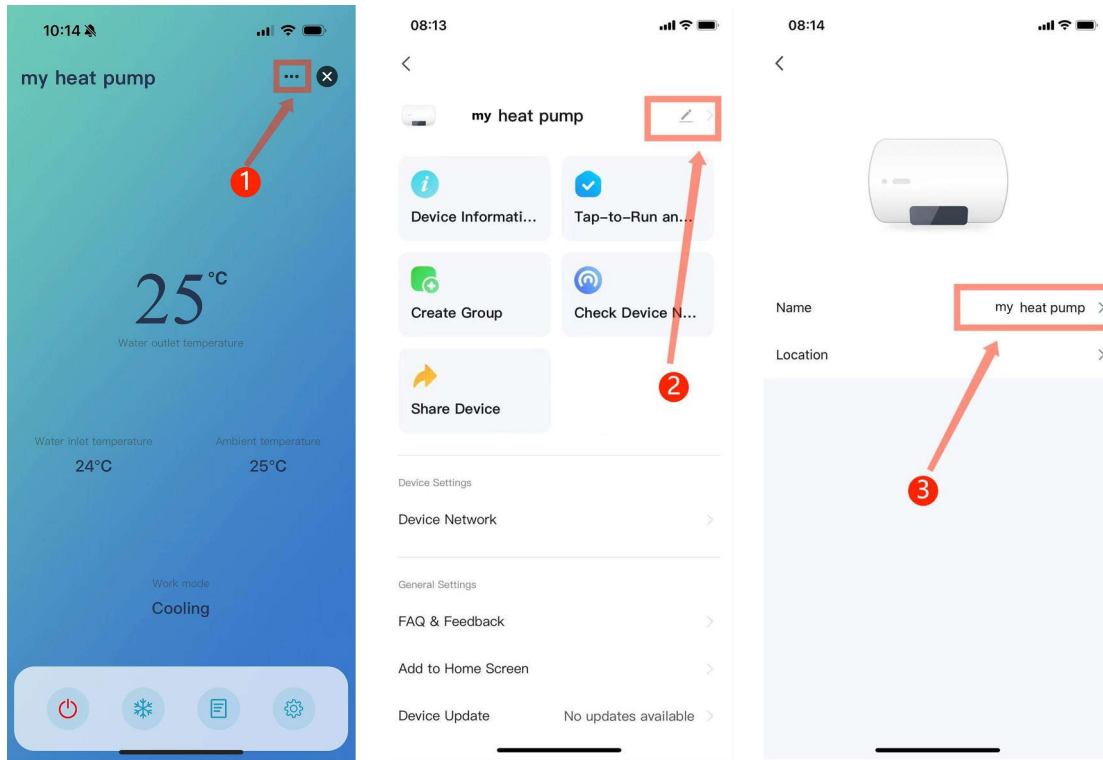

### 3) Device Sharing

To share a bound device, the sharer follows the following steps: click "More" → "Shared Device" → "Add" → enter the account of the person to be shared with, click "Finish", and the newly added account of the person to be shared will be displayed in the list of successful sharing ;

If you need to delete the person you are sharing with, long press the selected user, the deletion interface will pop up, click "Delete" ;

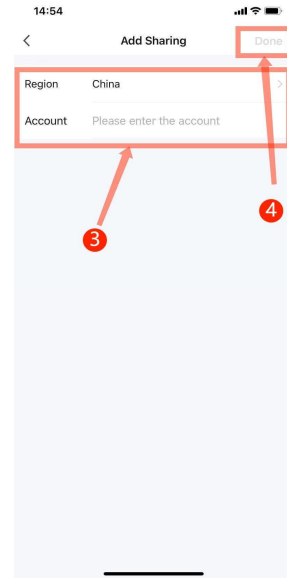
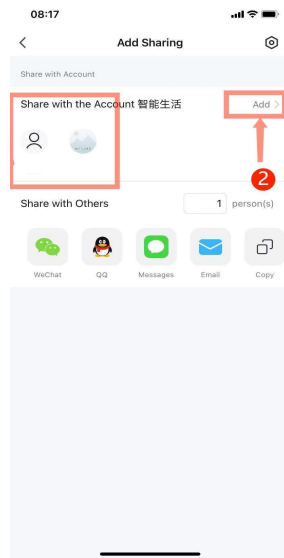
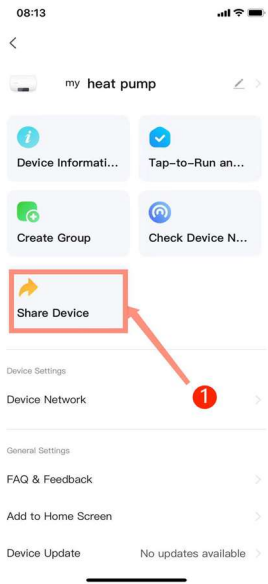

## 11.4 Mode Settings

When the device is powered on, click "  " on the main interface to switch modes. The mode selection interface will pop up as shown below. Click the mode you want to select.

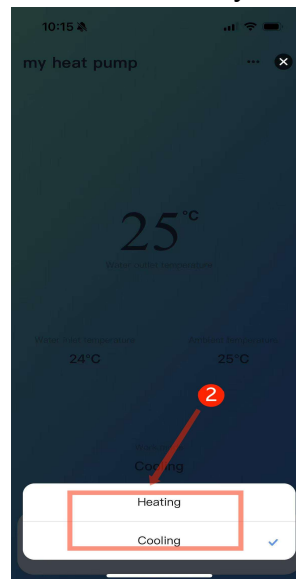
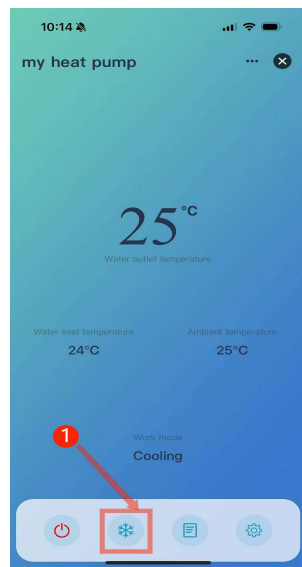

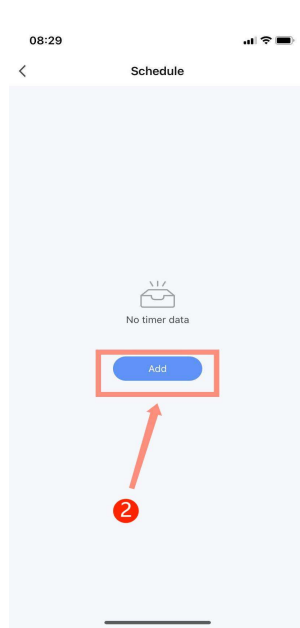
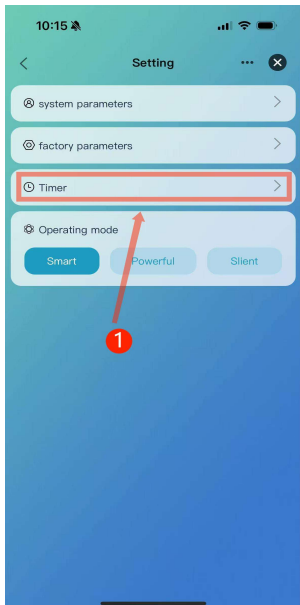

## 11.5 Timing Settings

Click "  " on the main interface of the device operation to enter the "Settings" menu, find "Schedule" to enter the schedule setting interface, select "Add" → adjust "Clock" → "Minutes" according to the situation → Select the days to execute → Execute notification → Select "Turn on" or "Turn off" as shown below, and click Add Schedule;  
If you want to delete a timer, press and hold the timer item and swipe left to pop up the "Delete" icon. Click it to delete.



## 11.6 Device Removal

On the main interface, click "  " in the upper right corner to enter the device details interface. Click "Remove Device" at the bottom of the device details interface, and the wired controller will enter the intelligent network configuration mode. The "  " icon will not flash, and the network configuration can be re-established within 3 minutes. If more than 3 minutes pass, the network configuration will be exited. The specific operations are as shown in the following sequence;

