



OWNER'S MANUAL

# AIR-TO-WATER HEAT PUMP

---



Please read this manual carefully before operating your set and retain it for future reference.

Original instruction

**ENGLISH**

**ITALIANO**

**ESPAÑOL**

**FRANÇAIS**

**DEUTSCH**

**CATALÀ**

Outdoor Unit

HM121 / 141 / 161HF UB60

HM123 / 143 / 163HF UB60

HM093HFX UB60

HM071 / 091HF UB40

HM073 / 093HF UB40

Indoor Unit

PHCM0

# INTRODUCTION

### Read this manual

Inside you will find many helpful hints on how to use and maintain your AWHP properly. Just a little preventive care on your part can save you a great deal of time and money over the life of your product.

You'll find many answers to common problems in the chart of troubleshooting tips. If you review our chart of Troubleshooting Tips first, you may not need to call for service at all.

### How to find additional model information

Energy Labels and Product Fiches for all possible combinations can be found at

<https://www.lg.com/global/support/cedoc/cedoc>.

Search for outdoor unit name in cedoc page.

### *For your records*

Staple your receipt to this page in case you need it to prove the date of purchase or for warranty purposes. Write the model number and the serial number here:

Model number :

---

Serial number :

---

You can find them on a label on the side of each unit.

Dealer's name :

---

Date of purchase :

# TABLE OF CONTENTS

This manual may contain images or content different from the model you purchased.

This manual is subject to revision by the manufacturer.

<b>INTRODUCTION.....</b>	<b>2</b>
<b>SAFETY INSTRUCTIONS.....</b>	<b>5</b>
READ ALL INSTRUCTIONS BEFORE USE.....	5
WARNING INSTRUCTIONS .....	6
CAUTION INSTRUCTIONS.....	12
<b>PRODUCT INTRODUCTION .....</b>	<b>16</b>
Remote controller .....	17
<b>DESCRIPTION OF THE OPERATION .....</b>	<b>18</b>
Main screen.....	18
Menu screen .....	18
Setting screen.....	19
Monitoring screen.....	21
Returning to the screen .....	21
<b>TEMPERATURE SETTING .....</b>	<b>22</b>
Controlling desired temperature .....	22
<b>OPERATION SETTING .....</b>	<b>23</b>
On / Off.....	23
Operation mode.....	23
Cooling operation .....	24
Heating operation.....	25
Auto operation .....	26
DHW heating operation .....	27
Power DHW tank heating.....	27
<b>OVERVIEW OWNER'S SETTINGS.....</b>	<b>28</b>
Menu structure.....	28
<b>FUNCTION .....</b>	<b>30</b>
Silent Mode .....	30
3rd Party Boiler.....	31
Wi-Fi Pairing.....	31
Domestic Hot Water Mode.....	32
<b>SCHEDULE SETTING.....</b>	<b>33</b>
Schedule - Circuit.....	33
Schedule - DHW.....	36
Schedule - Silent Mode.....	39
Schedule - Edit Exception Day.....	40

# TABLE OF CONTENTS

<b>TIMER</b> .....	<b>41</b>
Simple Timer .....	41
Turn-Off Reservation .....	42
Turn-On Reservation.....	42
After timer setting.....	42
<b>ENERGY</b> .....	<b>43</b>
Energy Initialization .....	44
<b>GENERAL SETTINGS</b> .....	<b>45</b>
Language .....	45
Temperature Unit.....	46
Screen Saver .....	47
Date & Time .....	49
Schedule Reset .....	50
System Reboot.....	50
Lock.....	51
<b>SVC CONTENTS</b> .....	<b>52</b>
Service Contact.....	52
Model Information.....	53
SW Version .....	53
Open Source License .....	53
Software Update .....	54
Setup.....	55
<b>USING THERMOSTAT</b> .....	<b>56</b>
How to use thermostat.....	56
<b>EMERGENCY OPERATION</b> .....	<b>57</b>
<b>MAINTENANCE AND SERVICE</b> .....	<b>60</b>
Maintenance activities.....	60
When the unit is not going.....	60
Call the service immediately in the following situations.....	61

# SAFETY INSTRUCTIONS

## READ ALL INSTRUCTIONS BEFORE USE

The following safety guidelines are intended to prevent unforeseen risks or damage from unsafe or incorrect operation of the appliance.

### Safety Messages



This symbol is displayed to indicate matters and operations that can cause risk.

Read the part with this symbol carefully and follow the instructions in order to avoid risk.



#### **WARNING**

This indicates that the failure to follow the instructions can cause serious injury or death.



#### **CAUTION**

This indicates that the failure to follow the instructions can cause the minor injury or damage to the product.

## Notes for Flammable Refrigerant

The following symbols are displayed on units.



This symbol indicates that this appliance uses a flammable refrigerant. If the refrigerant is leaked and exposed to an external ignition source, there is a risk of fire.



This symbol indicates that the Owner's Manual should be read carefully.



This symbol indicates that service personnel should be handling this equipment with reference to the Installation Manual.



This symbol indicates that information is available in the Owner's Manual or Installation Manual.

## WARNING INSTRUCTIONS

---

### **WARNING**

- To reduce the risk of explosion, fire, death, electric shock, injury or scalding to persons when using this product, follow basic precautions, including the following:

---

  - Always ground the product.
    - There is a risk of electric shock.

- Do not use a defective or underrated circuit breaker. Use the correctly rated breaker and fuse.
  - There is risk of fire or electric shock.
- Do not use a multi outlet. Always use this appliance on a dedicated circuit and breaker.
  - There is risk of fire or electric shock.
- For electrical work, contact the dealer, seller, a qualified electrician, or an Authorized Service Center. Do not disassemble or repair the product by yourself.
  - There is risk of fire or electric shock.
- Always ground the product as per the wiring diagram. Do not connect the ground wire to gas or water pipes lightning rod or telephone ground wire.
  - There is risk of fire or electric shock.
- Install the panel and the cover of control box securely.
  - There is risk of fire or electric shock due to dust, water etc.
- Use the correctly rated breaker or fuse.
  - There is risk of fire or electric shock.
- Do not modify or extend the power cable. If the power cable or cord has scratches or skin peeled off or deteriorated then it must be replaced.
  - There is risk of fire or electric shock.
- For installation, removal or reinstall , always contact the dealer or an Authorized Service Center.
  - There is risk of fire, electric shock, explosion, or injury.
- Do not install the product on a defective installation stand. Be sure that the installation area does not deteriorate with age.
  - It may cause product to fall.

- Never install the unit on a moving base or a place from where it can fall down.
  - The falling unit can cause damage or injury or even death of a person.
- When the product is soaked (flooded or submerged) in water, contact an Authorized Service Center for repair before using it again.
  - There is risk of fire or electric shock.
- Be sure to check the refrigerant to be used. Please read the label on the product.
  - Incorrect refrigerant can prevent the normal operation of the unit.
- Don't use a power cord, a plug or a loose socket which is damaged.
  - Otherwise it may cause a fire or electrical shock.
- Do not touch , operate, or repair the product with wet hands.
  - There is risk of electric shock or fire.
- Do not place a heater or other heating appliances near the power cable.
  - There is risk of fire and electric shock.
- Do not allow water to run into electric parts. Install the unit away from water sources.
  - There is risk of fire, failure of the product, or electric shock.
- Do not store or use or even allow flammable gas or combustibles near the outdoor unit. (especially in protect zone.)
  - There is risk of fire.
- Wiring connections must be secured tightly and the cable should be routed properly so that there is no force pulling the cable from the connection terminals.
  - Improper or loose connections can cause heat generation or fire.

- Safely dispose off the packing materials. Like screws, nails, batteries, broken things etc after installation or service and then tear away and throw away the plastic packaging bags.
  - Children may play with them and cause injury.
- Make sure to check that the power device is not dirty, loose or broken and then turn on the power.
  - Dirty, loose or broken power device can cause electric shock or fire.
- In unit the step-up capacitor supplies high voltage electricity to the electrical components. Be sure to discharge the capacitor completely before conducting the repair work.
  - An charged capacitor can cause electrical shock.
- When installing the unit, use the installation kit provided with the product.
  - Otherwise the unit may fall and cause severe injury.
- Be sure to use only those parts which are listed in the service parts list. Never attempt to modify the equipment.
  - The use of inappropriate parts can cause an electrical shock, excessive heat generation or fire.
- Do not use the product in a tightly closed space for a long time. Perform ventilation regularly.
  - Oxygen deficiency could occur and hence harm your health.
- Do not open the front cover or grille of the product during operation. (Do not touch the electrostatic filter, if the unit is so equipped.)
  - There is risk of physical injury, electric shock, or product failure.
- If strange sounds, smell or smoke comes from product, immediately turn the breaker off or disconnect the power supply cable.
  - There is risk of electric shock or fire.

## 10 SAFETY INSTRUCTIONS

---

- Ventilate the product room from time to time when operating it together with a stove, or heating element etc.
  - Oxygen deficiency can occur and hence harm your health.
- Turn the main power off when cleaning or repairing the product.
  - There is risk of electric shock.
- Take care to ensure that nobody especially kids could step on or fall onto the unit.
  - This could result in personal injury and product damage.
- Take care to ensure that power cable could not be pulled out or damaged during operation.
  - There is risk of fire or electric shock.
- Do not touch any electric part with wet hands. you should be cut power before touching electric part.
  - There is risk of electric shock or fire.
- Do not touch refrigerant pipe and water pipe or any internal parts while the unit is operating or immediately after operation.
  - There is risk of burns or frostbite, personal injury.
- If you touch the pipe or internal parts, you should be wear protection or wait time to return to normal temperature.
  - Otherwise , it may cause burns or frostbite, personal injury.
- Do not touch leaked refrigerant directly.
  - There is risk of frostbite.
- Make sure to install mixing valve (field supply). The mixing valve is limiting the water temperature. The hot water temperature maximum values shall be selected according to the applicable legislation.
- Do not heated to a temperature of more than provided by the product.
  - Otherwise, it may cause fire or damage of product.

- This appliance is intended to be used by expert or trained users in shops, in light industry and on farms, or for commercial use by lay persons.
- Do not step on the unit and do not put anything on it. It may cause an injury through dropping of the unit or falling down.
- Use a vacuum pump or Inert (nitrogen) gas when doing leakage test or air purge. Do not compress air or Oxygen and Do not use Flammable gases. Otherwise, it may cause fire or explosion.
  - There is the risk of death, injury, fire or explosion.
- The appliance shall be stored in a well-ventilated area where the room size corresponds to the room area as specified for operation.
- The appliance shall be stored in a room without continuously operating open flames (for example an operating gas appliance) and ignition sources (for example an operating electric heater).
- The appliance shall be stored so as to prevent mechanical damage from occurring.
- Any person who is involved with working on or breaking into a refrigerant circuit should hold a current valid certificate from an industry-accredited assessment authority, which authorises their competence to handle refrigerants safely in accordance with an industry recognised assessment specification. (Include the corresponding tools and required personal protective equipment)
- Any person who is involved with working on or breaking into a refrigerant circuit wear appropriate protective equipment and have a fire extinguisher available.
- Keep any required ventilation openings clear of obstruction.

- Servicing shall only be performed as recommended by the equipment manufacturer. Maintenance and repair requiring the assistance of other skilled personnel shall be carried out under the supervision of the person competent in the use of flammable refrigerants.
- The appliance shall be stored in a well-ventilated area where the room size corresponds to the room area as specified for operation.
- The appliance shall be stored in a room without continuously operating open flames (for example an operating gas appliance) and ignition sources (for example an operating electric heater).
- The appliance shall be installed in accordance with the national wiring regulation.
- If the supply cord is damaged, it must be replaced by the manufacturer, its service agent or similarly qualified persons in order to avoid a hazard.

## CAUTION INSTRUCTIONS

---

### CAUTION

- To reduce the risk of minor injury to persons, malfunction, or damage to the product or property when using this product, follow basic precautions, including the following:
- 
- Two or more people must lift and transport the product.
    - Avoid personal injury.
  - Do not install the product where it will be exposed to sea wind (salt spray) directly.
    - It may cause corrosion on the product.

- Keep level even when installing the product.
  - To avoid vibration or noise.
- Do not install the product where the noise or hot air from the unit could damage or disturb the neighborhoods.
  - It may cause a problem for your neighbors and hence dispute.
- Always check for gas (refrigerant) leakage after installation or repair of product.
  - Low refrigerant levels may cause failure of product.
- Do not use the product for special purposes, such as preserving foods, works of art, etc. It is a consumer heat pump, not a precision refrigeration system.
  - There is risk of damage or loss of property.
- Do not block the inlet or outlet of air flow.
  - It may cause product failure.
- Use a soft cloth to clean. Do not use harsh detergents, solvents or splashing water etc.
  - There is risk of fire, electric shock, or damage to the plastic parts of the product.
- Do not step on or put anything on the product.
  - There is risk of personal injury and failure of product.
- Do not insert hands or other objects through the air inlet or outlet while the product is operating.
  - There are sharp and moving parts that could cause personal injury.
- Be cautious when unpacking and installing the product.
  - Sharp edges could cause injury.
- If the refrigerant gas leaks during the repair, do not touch the leaking refrigerant gas.
  - The refrigerant gas can cause frostbite (cold burn).

- Do not tilt the unit when removing or uninstalling it.
  - The condensed water inside can spill.
- Do not mix air or gas other than the specified refrigerant used in the system.
  - If air enters the refrigerant system, an excessively high pressure results, causing equipment damage or injury.
- If the refrigerant gas leaks during the installation, ventilate the area immediately.
  - Otherwise it can be harmful for your health.
- Dismantling the unit, treatment of the refrigerant oil and eventual parts should be done in accordance with local and national standards.
- If the unit is not used for long time, we strongly recommend not to switch off the power supply to the unit.
  - There is risk of water freezing.
- If the unit is not used and switch off the power supply to the unit for long time, we strongly recommend to drain off all water in the unit by certificated person
  - There is risk of water freezing.
- Do not expose your skin or kids or plants to the cool or hot air draft.
  - This could harm to your health.
- Use a firm stool or ladder when cleaning, maintaining or repairing the product at an height.
  - Be careful and avoid personal injury.
- The hot water may not be available immediately, during disinfection operation or depending on the amount of hot water.
- During floor heating operation it is important to limit the minimum/maximum water temperature.

- If anyone other than a licensed Professional installs, repairs, or alters LG Electronics Air Conditioning Products, the warranty is voided.
  - All costs associated with repair are then the full responsibility of the owner.
- Do not install the unit in potentially explosive atmospheres.
- Refrigerants are pre-charged in the factory to the outdoor unit. Additional refrigerants need to be charged depending on the length and size of pipe.
- This appliance is not intended for use by persons (including children) with reduced physical, sensory or mental capabilities or lack of experience and knowledge, unless they have been given supervision or instruction concerning use of the appliance by a person responsible for their safety. Children should be supervised to ensure that they do not play with the appliance.
- This appliance can be used by children aged from 8 years and above and persons with reduced physical, sensory or mental capabilities or lack of experience and knowledge if they have been given supervision or instruction concerning use of the appliance in a safe way and understand the hazards involved. Children shall not play with the appliance. Cleaning and user maintenance shall not be made by children without supervision.

# PRODUCT INTRODUCTION

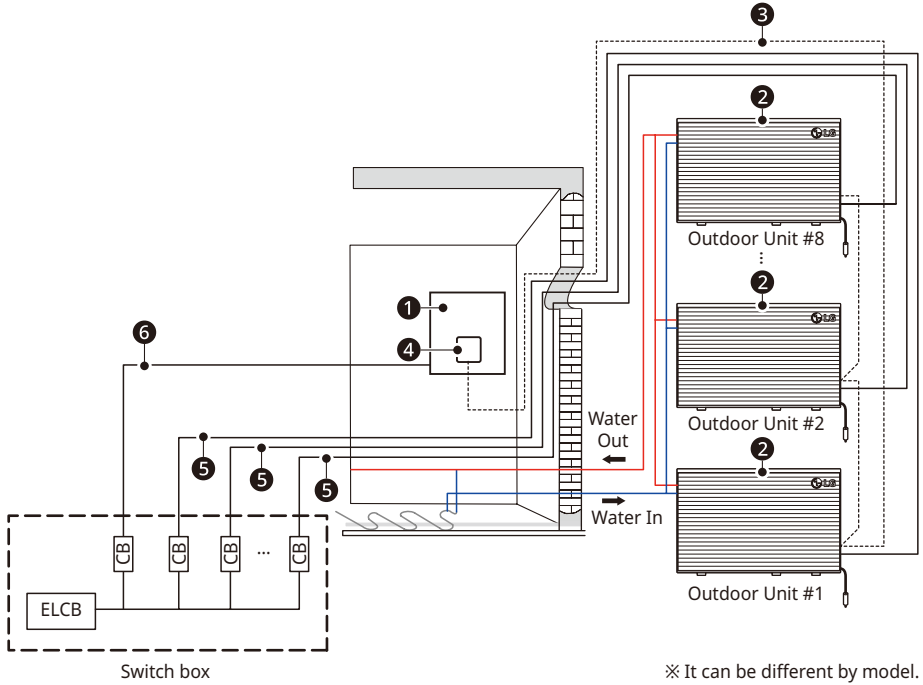

## Description

No	Name	No	Name
①	Cascade control unit	④	Remote controller
②	Outdoor unit	⑤	Power supply outdoor unit
③	Communication cable	⑥	Power supply indoor unit

- ELCB : Earth-leakage circuit breaker
- CB : Circuit breaker

## NOTE

- Voltage supplied to the unit terminals should be within the minimum and maximum range.
- Maximum allowable voltage unbalance between phase is 2%.
- All installation sites must be equipped with an earth leakage circuit breaker(ELCB).
- Cascade control unit can only be combined with the same outdoor unit.  
ex) HM161HF + HM161HF (O), HM161HF + HM141HF (X)

## Remote controller

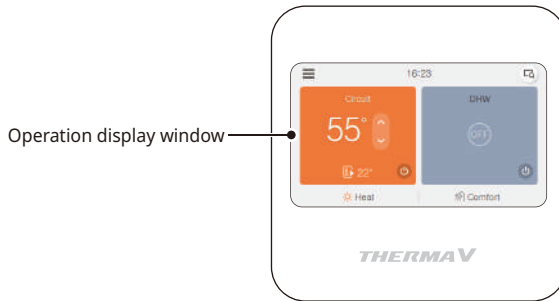

<b>Operation display window</b>	Operation and Settings status display
---------------------------------	---------------------------------------

### NOTE

- The remote controller is located on the indoor unit from factory.
- Some functions may not be operated and displayed depending on the product type.
- The actual product can be different from above contents depending upon model type.
- When using simultaneous operation system, whenever press remote controller button, system will approximately operate after 1~2 minutes.

# DESCRIPTION OF THE OPERATION

## Main screen

In the main screen, you can move to other screen by pressing the button.



## Menu screen

In the main screen, press [] button to move to the menu screen.

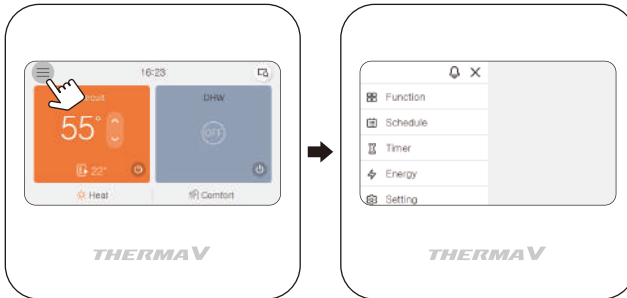

In the menu screen, press [**Setting**] category to move to setting screen.

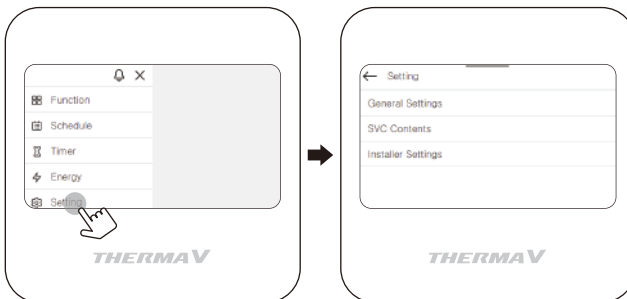

## Setting screen

Press the category to move to detail screen.

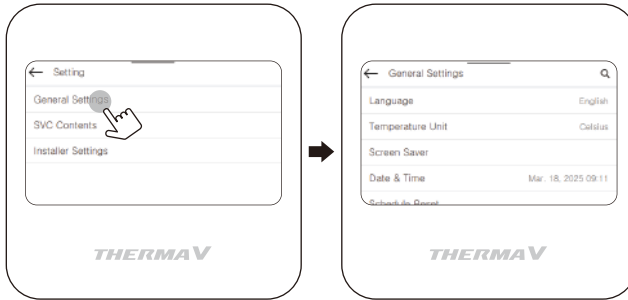

Slide up and down the screen to see all categories.

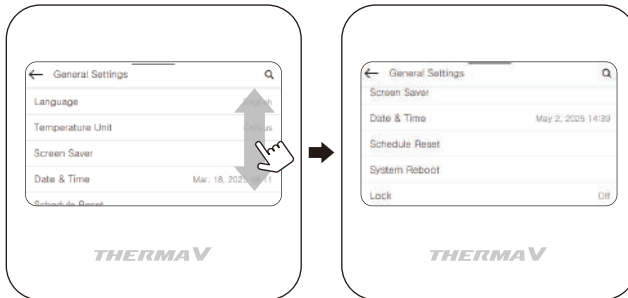





## 20 DESCRIPTION OF THE OPERATION

---

In each detail screen of the menu, as in the box in the left figure, you can move to the detail setting screen by pressing the category.



In each detail screen of the menu, as in the box in the left figure, if [  ] or [  ] button is displayed, you can change the function's status by pressing the button.

- [  ] button means that the function's status is ON.
- [  ] button means that the function's status is OFF.

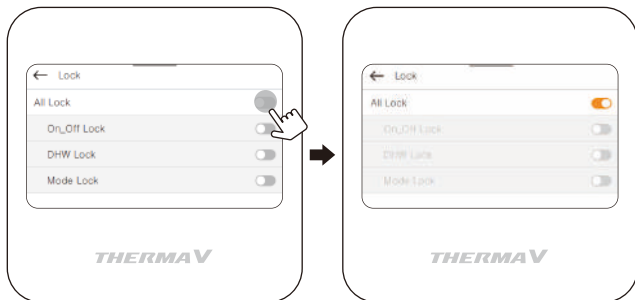

---

### NOTE

- For the values that can be set in each category, refer to the detail manual for each function.
-

## Monitoring screen

In the main screen, you can enter the monitoring screen by pressing [  ] button

In the monitoring screen, you can check the following information,

- The room temperature (if applicable)
- The water inlet / outlet temperature
- The water pump operation
- The water flow rate
- The water pressure
- The solar heat temperature (if applicable)
- The outdoor temperature

### NOTE

- Some information may not be visible if the function is disabled or not available for the model.



## Returning to the screen

If there is no user interaction for 1 minute, it moves to the main screen.

# TEMPERATURE SETTING

## Controlling desired temperature

You can easily control to the desired temperature.

- In the main screen, press [ $\wedge$ ,  $\vee$  (up/down)] button to set the desired temperature.
  - In the cooling, heating, and auto mode, the desired temperature control is possible.

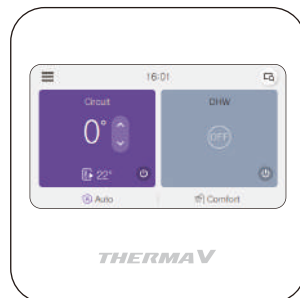

Setting	Description
Leaving water temperature	If the desired temperature is lower than the water temperature, the heating is not performed. Set the desired temperature higher than the water temperature. (In cooling mode desired temperature is higher than the water temperature, the cooling is not performed.)
DHW tank temperature	DHW tank temperature setting is available when DHW tank is installed.

- Temperature of Circuit1 and Circuit2 can be set respectively, when 2nd circuit option is activated in installer setting.



## NOTE

- The function can be activated according to the installer setting.
- Circuit 1 = Direct circuit
- Circuit 2 = Mixing circuit

# OPERATION SETTING

## On / Off

**THERMAV**™ will be turned on or off.

Press the remote controller's  [On/Off] button.

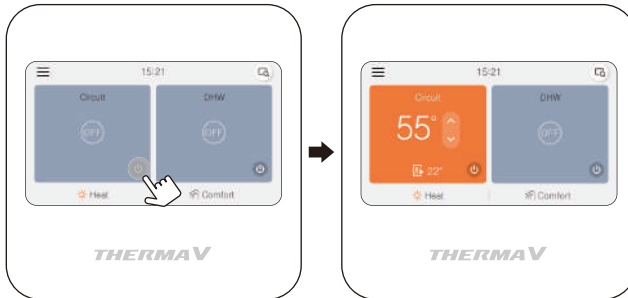

## Operation mode

You can easily control the desired operation mode.

- Some products may not support some operation modes.

Mode	Description
Cool	Cool the room to the desired temperature. Activated when No. 4 ON of indoor unit PCB DIP SW 2. (Refer to Installer manual.)
Heat	Heats the room to the desired temperature.
Auto	Mode and set temperature are adjusted automatically related to outside temperature (as set by Installer). Temperature adjustment is possible.

※ When Remote controller is off, Only frost protection is enabled.

## WARNING

- Cooling should only be activated, if the distribution system is designed to carry cold water. Misuse can lead to damages.

# Cooling operation

Cooling operation's minimum setting temperature is 5 °C.

- The desired temperature can be controlled in the units of 1 °C.
  - Set the desired temperature lower than the water temperature.
  - water temperature is displayed on the default screen of the remote controller.
  - If your unit is operating in cooling mode and you press the **[On/Off]** button the cooling operation will shut off.



---

### NOTE

- Activated when No. 4 ON of indoor unit PCB DIP SW 2 (Refer to Installer manual.)
    - Cooling operation must not be activated, if distribution system is not designed to carry cold water. Misuse can lead to damages.
- 

### What is 3 minutes delay function?

After the cooling stops, when the product is started right away, the reason that the cold water does not come out is that it is the function to protect the compressor.

The compressor starts after 3 minutes and the cold water comes out.

---

### NOTE

- In the cooling operation, you can select the desired temperature in the range of 5 °C~27 °C.
  - The favorable temperature difference between the water inlet temperature and outlet temperature is 5 °C.
-

## Heating operation

- The desired temperature can be controlled in the units of 1 °C.
  - Set the desired temperature higher than the water temperature.
  - Water temperature is displayed on the default screen of the remote controller.
  - If your unit is operating in heating mode and you press the [On/Off] button the heating operation will shut off.



### NOTE

In the heating operation, temperature setting range vary by model.

- You can select the desired temperature in the range of 15 °C ~ 70 °C.
- When the electric backup heater is not used, the minimum temperature of the water temperature can be set from 34 °C to 20 °C.

## Auto operation

In order to save energy and to give highest comfort, setting temperature will follow outside temperature. If outdoor temperature decreases, heating capacity for the house will increase automatically in order to keep same room temperature. All parameters will be set by installer during start-up procedure and will be adapted to the site characteristic.

- 1 Select Auto mode.

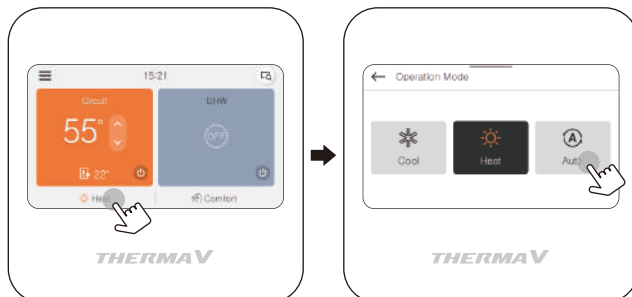

- 2 Adjust the desired temperature level by press [▲, ▼ (up/down)] button.



### NOTE

- The Auto temperature (set by Installer) can be adjusted if needed.
- -5 ~ -1: The preset temperature curve is lowered by 1 to 5 degrees.
- AI: Preset is kept.
- 1 ~ 5: The preset temperature curve is lifted by 1 to 5 degrees.
- <Temperature adjust step (unit : degrees)>
  - 5, -4, -3, -2, -1, 0, 1, 2, 3, 4, 5
  - ← Colder      Warmer →
- Refer to Installer manual for detailed explanation and guidance how to set the weather-dependent operation.

## DHW heating operation

Function to set whether or not to use a installed DHW tank.

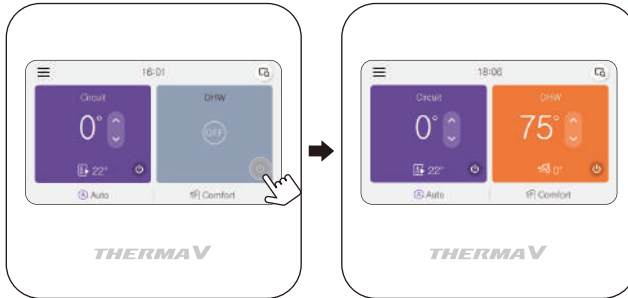

### NOTE

- This function is not used when the DHW tank is not installed.
- If you want to know more information, refer function on installation information section.

## Power DHW tank heating

If there is urgent DHW heating demand, Power DHW Tank Heating mode can be used to reduce the time to reach target DHW tank temperature by forcibly turning on DHW tank heater.

After reaching target DHW tank temperature or by user's input to stop, Power DHW Tank Heating mode will be finished.

- 1 Select Power mode.

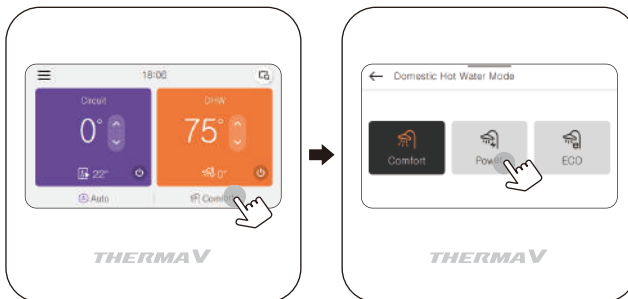

# OVERVIEW OWNER'S SETTINGS

## Menu structure

Menu			
	Function		
		Silent Mode	30
		3rd party boiler	31
		Wi-Fi Pairing	31
		Domestic Hot Water Mode	32
	Schedule		
		Circuit	33
		DHW	36
		Silent Mode	39
		Edit Exception Day	40
	Timer		
		Simple Timer	41
		Turn-Off Reservation	42
		Turn-On Reservation	42
		After timer setting	42
	Energy		
	Setting		
		General Settings	
		Language	45
		Temperature Unit	46
		Screen Saver	47
		Date & Time	49
		Schedule Reset	50
		System Reboot	50
		Lock	51

SVC Contents	
Service Contact	..... 52
Model Information	..... 53
SW Version	..... 53
Open Source License	..... 53
Software Update	..... 54
Setup	..... 55

# FUNCTION

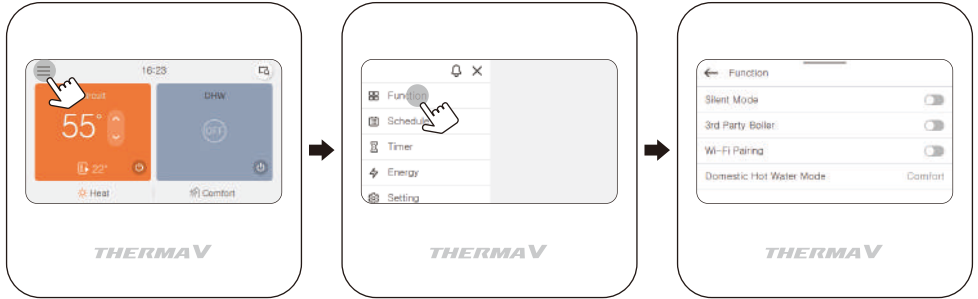

## Silent Mode

It is the function to operate the outdoor unit's silent mode.

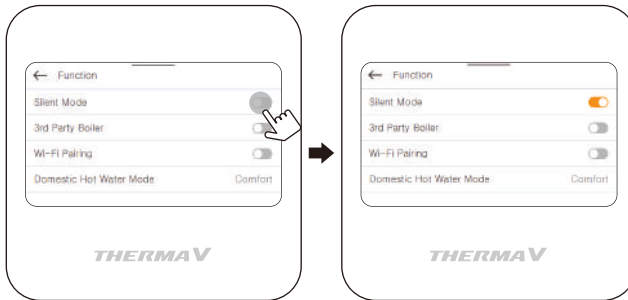

## NOTE

- Silent mode function can be set only when the installer setting's outdoor unit function Master/ Slave setting is set to "Master".
- Silent mode function is only available in some products.

## ! CAUTION

- When you enter the silent mode operation, the heating (cooling) capacity may be degraded.

## 3rd Party Boiler

It is the function to operate the 3rd party boiler.

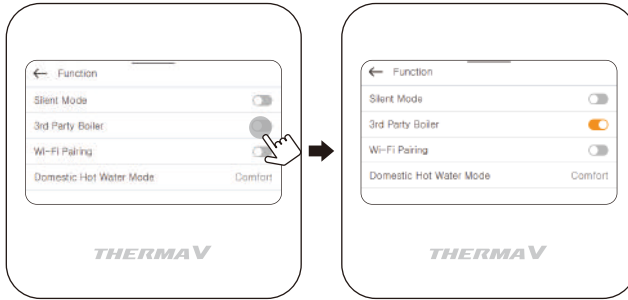

### NOTE

- This function is not default.
- It can be activated, after setting value in installer setting.

## Wi-Fi Pairing

It is the function to access the product through internet.

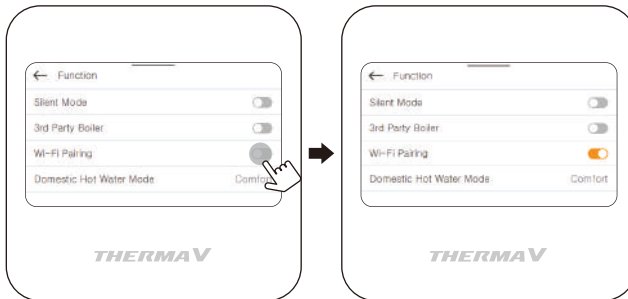

### NOTE

- A Wi-Fi modem (accessory) and a smart device with ThinQ app installed is required.

## Domestic Hot Water Mode

You can choose domestic hot water mode (Comfort / ECO) by pressing the category.  
ECO mode is an operation mode that can reduce electricity bill and improve efficiency.  
ECO mode has a relatively slow rise in hot water temperature compared to Comfort.

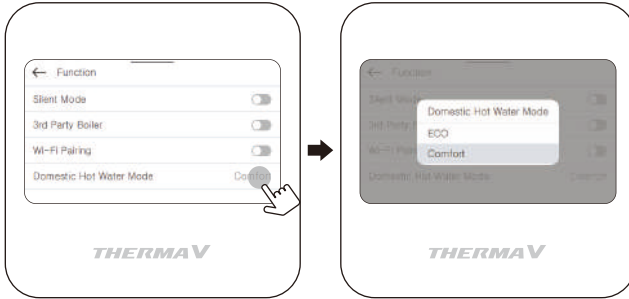

### NOTE

- You can also activate ECO mode in main screen.

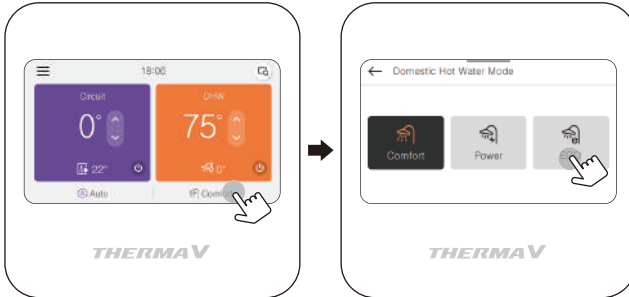

# SCHEDULE SETTING

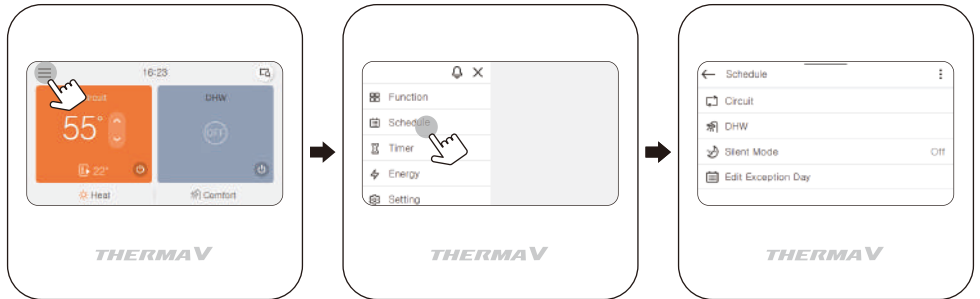

## Schedule - Circuit

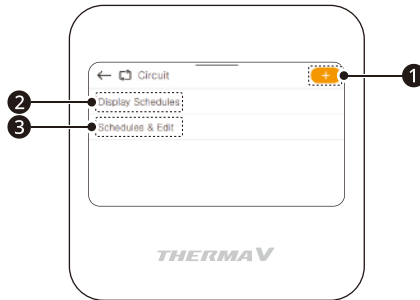

### 1 Add Schedule

- You can add schedule by pressing [ + ] button.

### 1 Time setting

- It sets the time to perform the schedule.

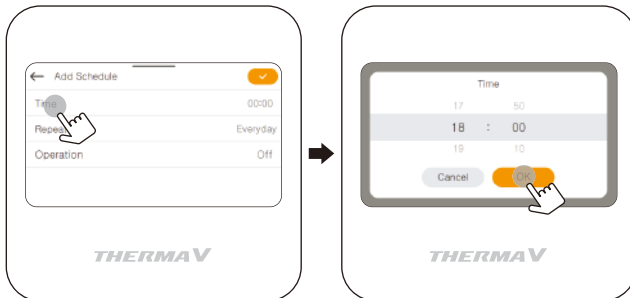

## 34 SCHEDULE SETTING

### 2 Repeat setting

- It sets the applied date and period for the schedule.
- You can select Every Week / Period selection.

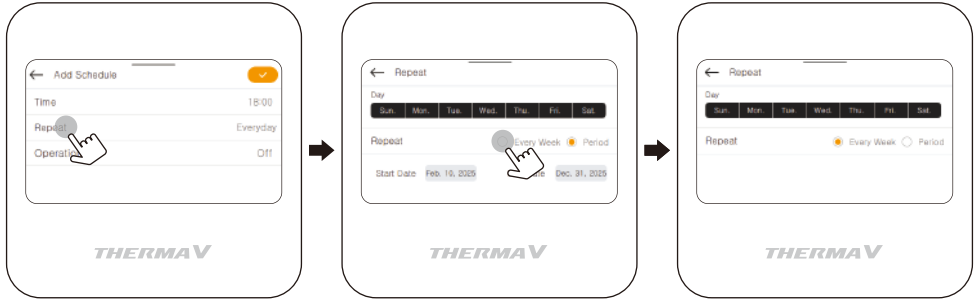

### 3 Operation setting

- It sets the operation for the schedule.
  - If you don't select any option in operation, the product will turn off at the set time.



### 4 Add schedule is completed

- If you press [  ] button, you can complete add schedule.

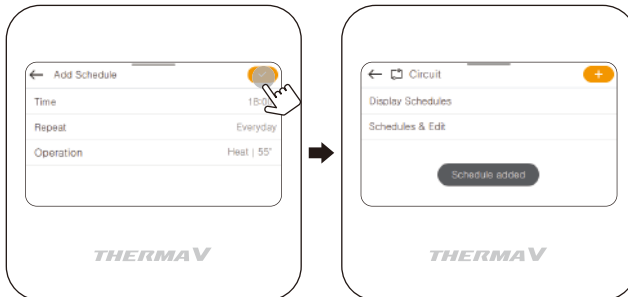

**2** Display Schedules

- It is the function that can check the status of the schedule saved in the remote controller.
- You can see the detail information of the schedule by pressing the icon.



**3** Schedules & Edit

- It is the function that can check the detail information of the schedule saved in the remote controller.

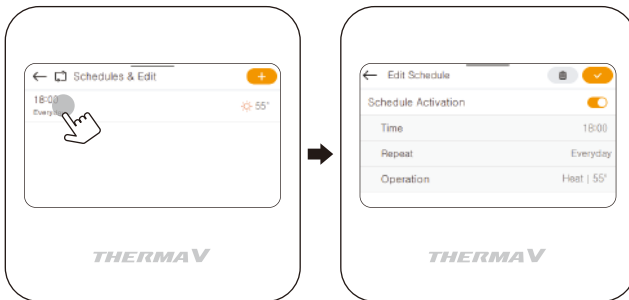

- You can edit the saved schedule's information.
  - Press the category [ Time / Repeat / Operation ] to move to the edit screen.
  - You can delete the saved schedule by pressing [  ] button.

# Schedule - DHW

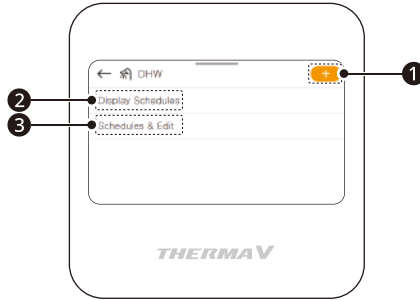

## 1 Add Schedule

- You can add schedule by pressing [ + ] button.

## 1 Time setting

- It sets the time to perform the schedule.

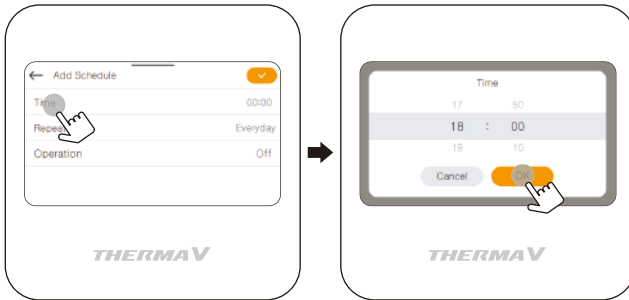

## 2 Repeat setting

- It sets the applied date and period for the schedule.
- You can select Every Week / Period selection.

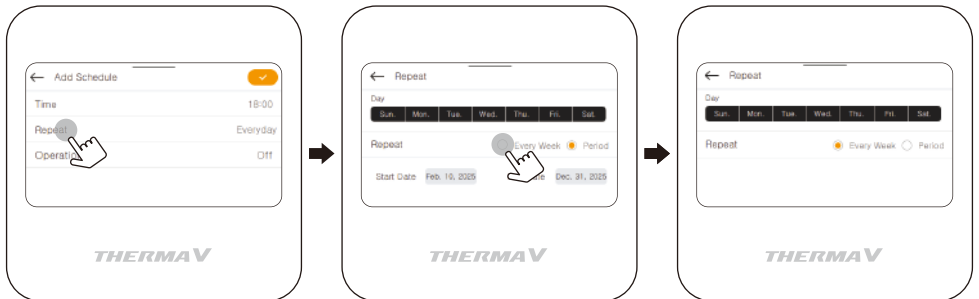

### 3 Operation setting

- It sets the operation for the schedule.
  - If you don't select any option in operation, the product will turn off at the set time.



### 4 Add schedule is completed

- If you press [  ] button, you can complete add schedule.

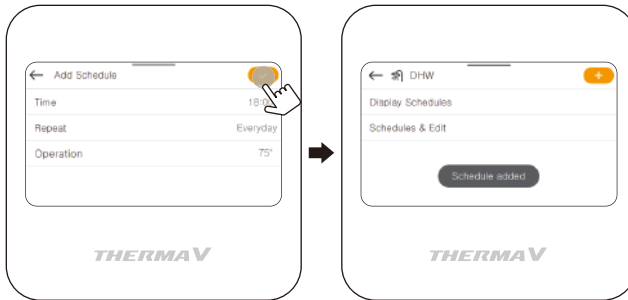

## 38 SCHEDULE SETTING

### 2 Display Schedules

- It is the function that can check the status of the schedule saved in the remote controller.
- You can see the detail information of the schedule by pressing the icon.

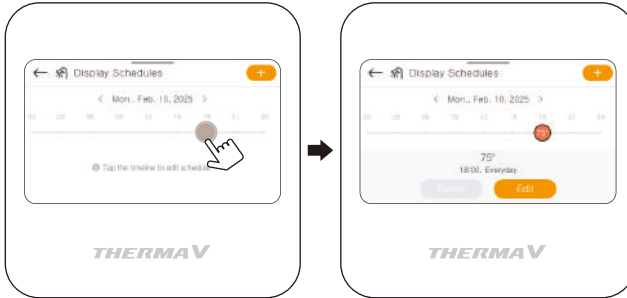

### 3 Schedules & Edit

- It is the function that can check the detail information of the schedule saved in the remote controller.

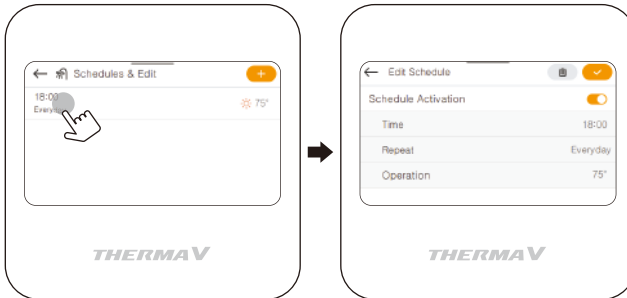



- You can edit the saved schedule's information.
  - Press the category [ Time / Repeat / Operation ] to move to the edit screen.
  - You can delete the saved schedule by pressing [  ] button.

## Schedule - Silent Mode

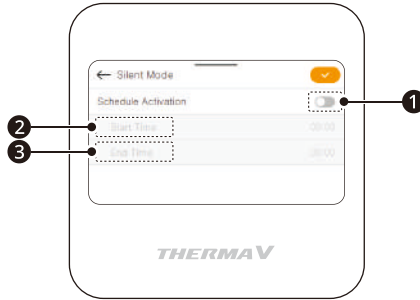
It is the function to set the start and end time of the outdoor unit's silent mode operation.





### 1 Schedule Activation

- You can activate silent mode schedule by pressing the button.
- [  ] button means that you don't activate the schedule.
- [  ] button means that you activate the schedule.

### 2, 3 Start Time / End Time

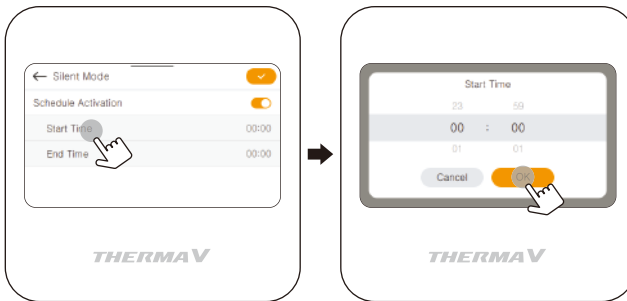
- It sets the start time / end time to perform the schedule.



If you press [  ] button, you can complete add schedule.

## NOTE

- Silent mode time setting function can be set only when the installer setting's outdoor unit function Master/Slave setting is set to "Master".
- Silent mode time setting function is only available in some products.

## CAUTION

- When you enter the silent mode operation, the heating (cooling) capacity may be degraded.

## Schedule – Edit Exception Day



It is the function to automatically stop the operation on the set day.

- You can add the exception day by pressing [  ] button.



- In detail screen, you can make exception day's title and select Every Year / Once selection.



- You can complete add exception day by pressing [  ] button.
- After you add the exception day, you can edit the exception day's information.
- You can delete the exception day by pressing [  ] button.



# TIMER

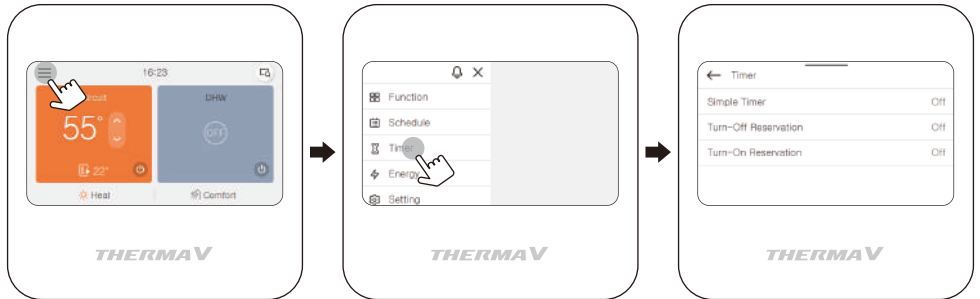

## Simple Timer

It is the function that can turn on/off the product after set time.

- It can be set in 1 minute increments.
  - If you set simple timer when the product is turned on, the product will be turned off after set time.
  - If you set simple timer when the product is turned off, the product will be turned on after set time.

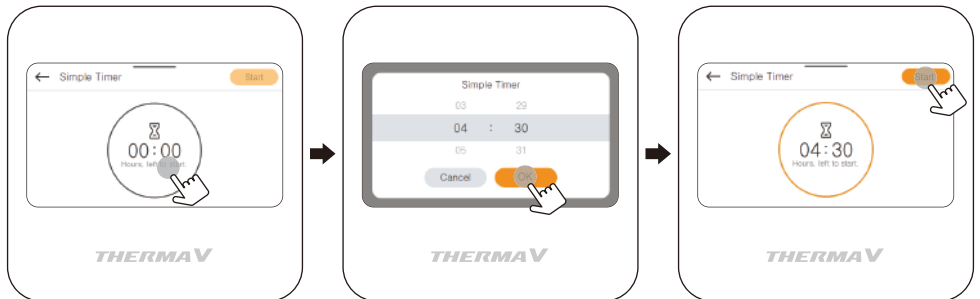

## Turn-Off Reservation

It is the function that can turn off the product after set time.

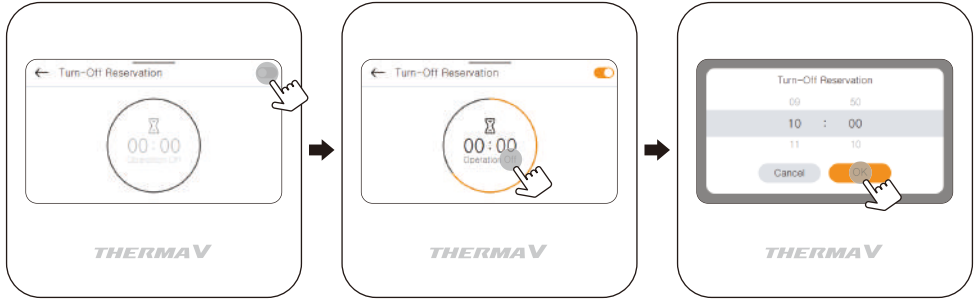

## Turn-On Reservation

It is the function that can turn on the product after set time.

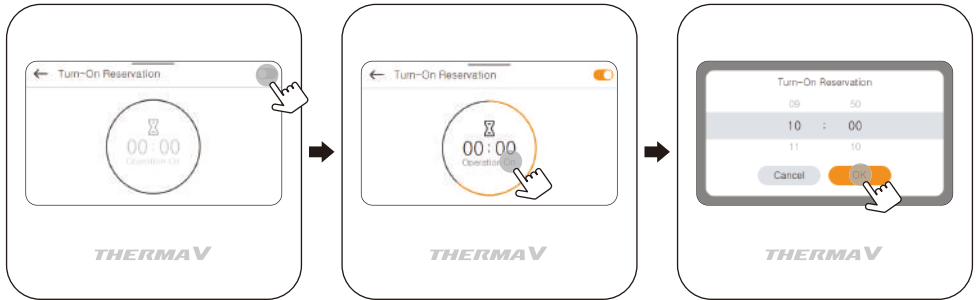

## After timer setting

You can see [ ⌚ ] button on main screen.

- If you press the button, you can move to timer setting screen.

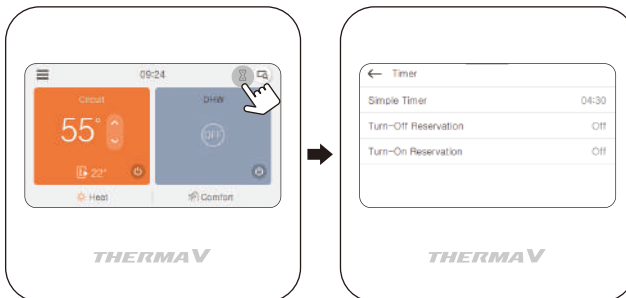

# ENERGY

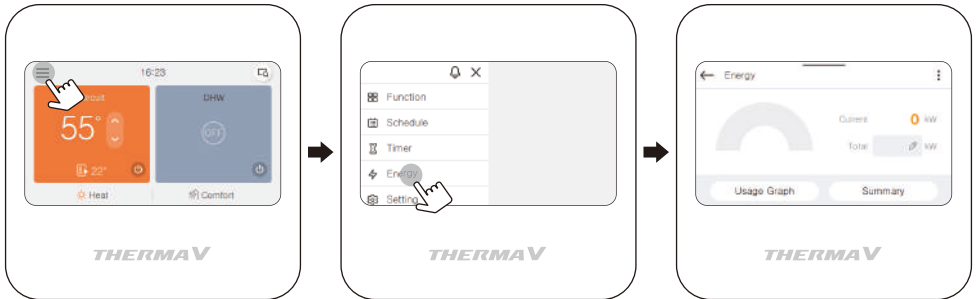

In energy screen, the amount of electrical energy consumed and thermal energy generated during week, month and year is displayed.

- If you press [**Usage Graph**] button, you can see information as a graph.
- If you press [**Summary**] button, you can see information as a table.



## NOTE

- The calculated produced heat output and power are an estimation, the accuracy cannot be guaranteed.
- The energy data should NOT be used for being invoiced or requested to government incentive and subsidy.
- If use antifreeze agent(the antifreeze short pin(CN\_ANTI\_SW) must be open and switch No.8 in Option SW 1 must be on.), then the produced heat will NOT be calculated, nor will it be displayed on the user interface. This is because the increase of fluid viscosity makes the accuracy of the flow measurement and thus the accuracy of heat metering unreliable. Calibrated external meter must be used in this case.

## Energy Initialization

It is the function to initialize all energy data.



# GENERAL SETTINGS

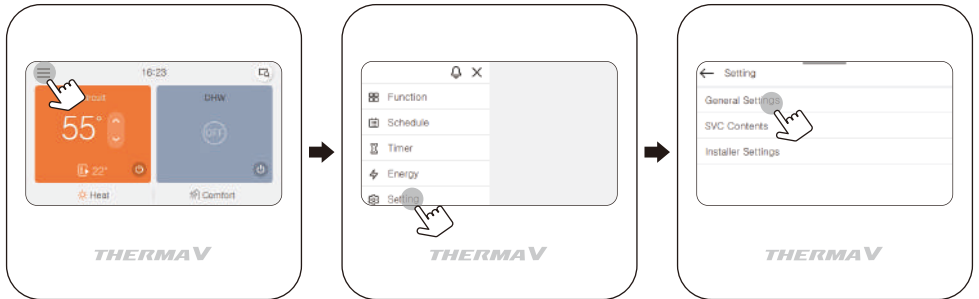

ENGLISH

## Language

Set the language to be displayed on the remote controller.



Language		
한국어	English	Français
Italiano	Deutsch	Español

## Temperature Unit

Set the temperature unit displayed on the remote controller.



Value	Celsius
	Fahrenheit

### CAUTION

- The temperature unit function may not work or work differently in some products.
- You cannot set the temperature unit in the slave wired remote controller.

## Screen Saver

If there is no user interaction, the screen saver will be activated and the brightness will be reduced.

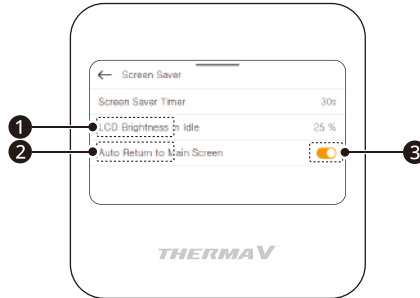

### 1 Screen Saver Timer

- After set time, the screen saver will be activated.



Value			
Off	15 seconds	30 seconds (default)	1 minute

## CAUTION

- Selecting longer stand by screen will decrease LCD lifespan.

## 48 GENERAL SETTINGS

### 2 LCD Brightness In Idle

- Adjust the remote controller's screen brightness.

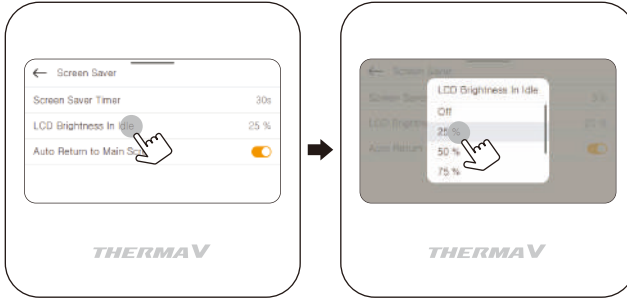



Value					
Off	25 % (default)	50%	75%	100%	Auto

### CAUTION

- Selecting brighter stand by screen will decrease LCD lifespan.

### 3 Auto Return to Main Screen

- Set the auto return mode.
- [  ] button means that you activate the auto return mode.
- [  ] button means that you don't activate the auto return mode.

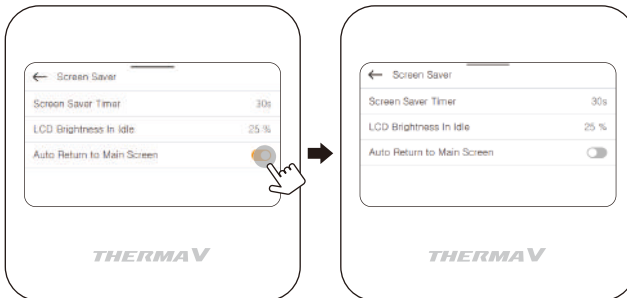

## Date & Time

Set the date, time displayed on the remote controller.

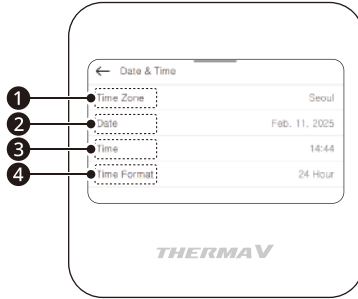

### 1 Time Zone

- Set your region in the time zone setting.

### 2 Date

- Set the date displayed on the remote controller.

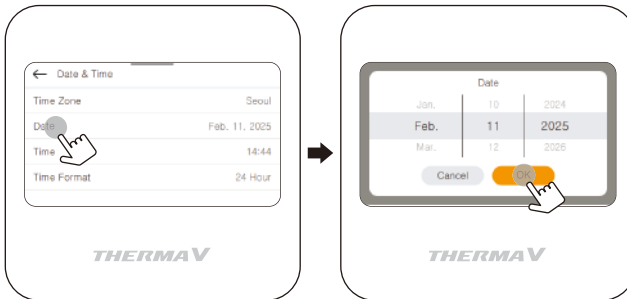

### 3 Time

- Set the time displayed on the remote controller.

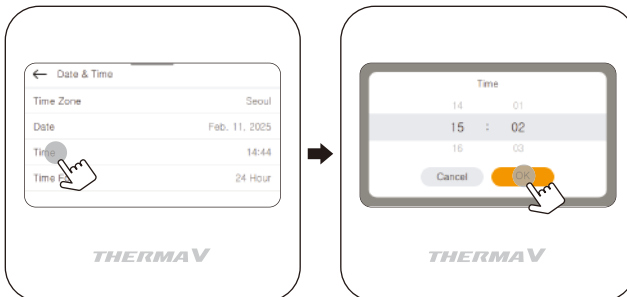

### 4 Time Format

- Time display can be presented in the form of AM / PM or 24 hours standard.

## Schedule Reset

Initialize all schedule settings in the remote controller.

- Press [**Schedule Reset**] category and press [**OK**] button to reset schedule in the remote controller.



## System Reboot

Restart the remote controller.

- Press [**System Reboot**] to move to detail screen.
  - In the detail screen, when you press [**Reboot**] button, a popup message is displayed.
  - Press [**OK**] button to restart the remote controller.

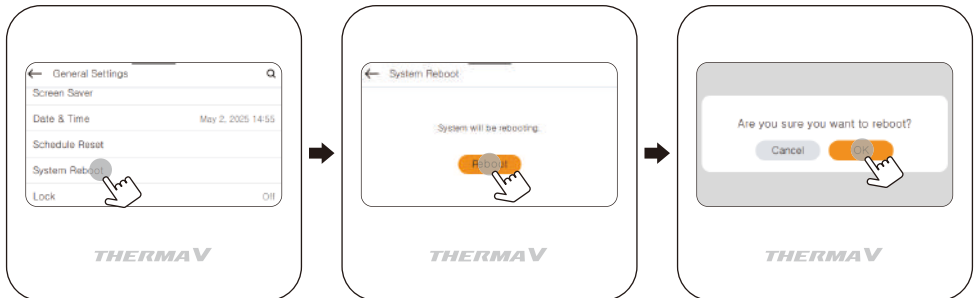

## Lock

It is the function to lock the button of the remote controller so that children or other persons cannot use it without permission.



Mode	Description
All Lock	It locks all button of the remote controller.
On/Off Lock	It locks the On/Off button of the remote controller.
DHW Lock	It locks the DHW On/Off button of the remote controller.
Mode Lock	It locks the operation mode button of the remote controller.

### NOTE

- DHW lock is not available when the DHW tank is not installed.
- In the central controller, when the central control temperature range lock is set, the wired remote controller's temperature lock setting is cleared.
- The temperature change by external equipment is reflected regardless of the remote controller temperature range lock.

## SVC Contents

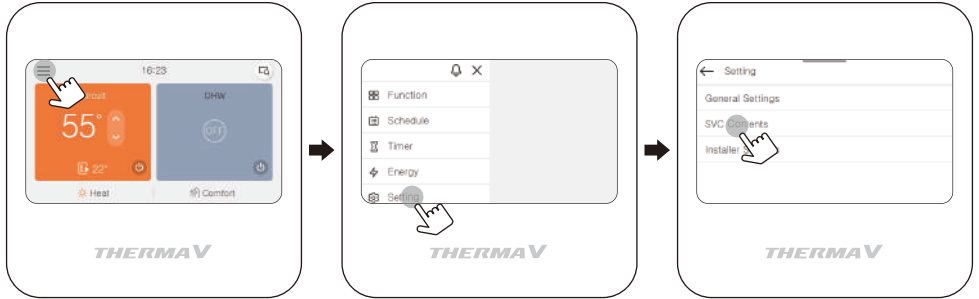

## Service Contact

View Service Contact for service telephone no. A phone number must be entered for this in advance. Ask to enter phone number when installing the product.



Press [  ] button to enter service center phone number.

## Model Information

View Model Information (Model / Serial No / Capacity).

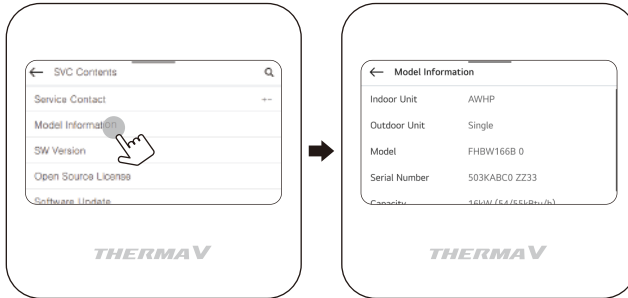

## SW Version

The software version of remote controller is displayed.

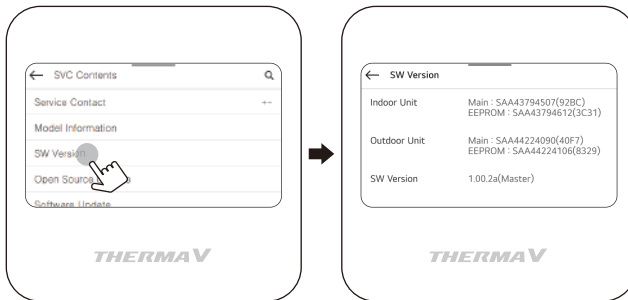

## Open Source License

The license of remote controller software is displayed.

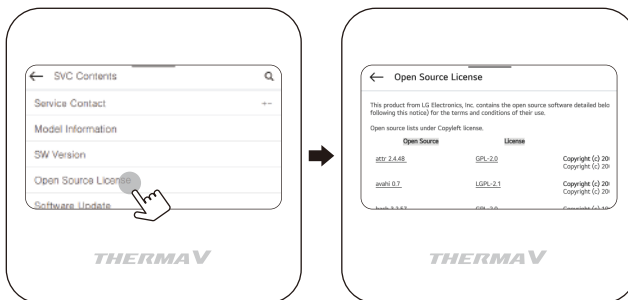

## Software Update

If necessary, the firmware of the remote controller can be updated through USB-port. This function shall be used only by professional user.

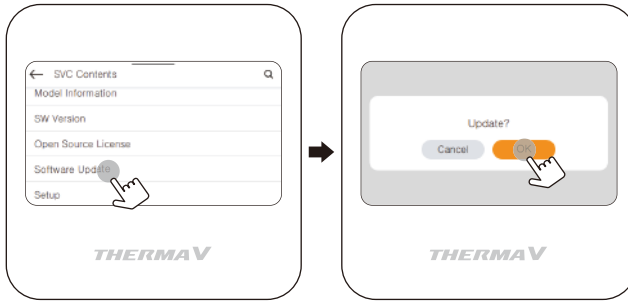

# Setup

You can setup some settings (Language / Date & Time / Customization).

## 1 Language

- Set the language to be displayed on the remote controller.

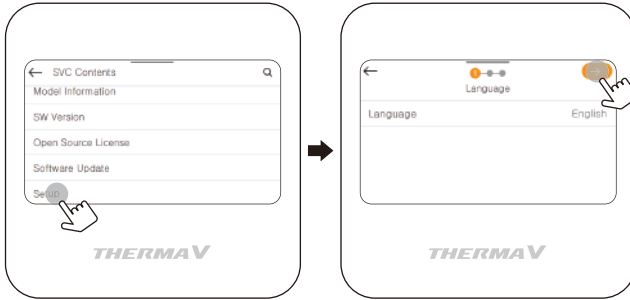

## 2 Date & Time

- Set the date, time displayed on the remote controller.



## 3 Customization

- You can customize some settings in this stage.

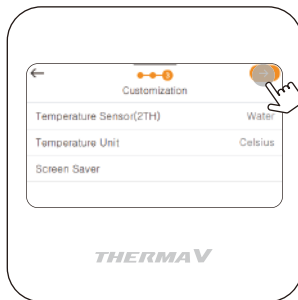

Press [  ] button to complete the setup.

## USING THERMOSTAT

The term "thermostat", which is widely used in this chapter, is a kind of 3rd party accessory. LG Electronics does not supply thermostat and it should be supplied 3rd party manufacturers.

Room thermostat can be used for easy and convenience control. To utilize thermostat more efficiently and correctly, this chapter presents information about using thermostat.

When thermostat is interlocked, the subject of Thermo On / Off is limited to the thermostat.

---

### CAUTION

- Some electro-mechanical type thermostat has internal delay time to protect compressor. In that case, mode change can takes time more than user's expectation. Please read thermostat manual carefully if the product does not response quickly.
- Setting temperature range by thermostat can be different with that of the product. The heating or cooling set temperature should be chosen within the setting temperature range of the product.

---

## How to use thermostat

To find how to turn on and off, how to set target temperature, how to change operating mode, etc, please refer thermostat operating manual provided by thermostat manufacturer.

## EMERGENCY OPERATION

- If your heat pump has an error, a pop-up window will appear on the screen. In any case you should note down the Error code displayed and inform your installer or authorized service center.
- If an electrical heater is connected, Emergency operation might be possible - depending how severe the error is. Refer to the table for more information.



- ※ Energy consumption will increase while using Emergency mode. It should not be used for long periods.

## Emergency operation is not automatically restarted after main electricity power is reset.

- In normal condition, the product operating information is restored and automatically restarted after main electricity power is reset.
- But in emergency operation, automatic re-start is prohibited to protect the product.
- Therefore, user must restart the product after power reset when emergency operation has been running.

### Error Code List

		Critical trouble / Error	Heavy trouble	Slight trouble	Option trouble
Description		Problem which can stop system operation, and can be resumed only after certificated professional's check.	Compressor cycle trouble. Emergency mode operation is performed by optional electric heater.	In most case, this trouble is concerned with sensor problems.	A problem is found for Option operation such as water tank heating.
Priority <sup>1)</sup>		1	2	3	4
Availability of Emergency mode	Heat pump cycle	X	X	O	O <sup>2)</sup>
	Backup heater	X	O <sup>3)</sup>	O	O <sup>2)</sup>
Related error codes		03, 09, 15, 16, 20		01, 02, 06, 17, 18, 19	08, 13

1) If more than one trouble occurs ("Duplicated trouble"), the trouble with higher priority defines the consequences (whether Emergency operation is possible or not).

2) Operation possible without optional function that has trouble. For instance, when DHW sensor is broken (CH08), hot water heating is not available.

3) Heating operation only. Not possible to use Cooling function.

- Main PCB assembly (Indoor)

Error Code	Description	Main Reasons
01*	Problem in Remote Room Air sensor	Remote air temperature sensor of Main PCB(indoor) is open or short.
02*	Problem in Refrigerant (Inlet side) sensor	Refrigerant inlet pipe temperature sensor of indoor unit is open or short..
03****	Communication error between indoor unit and wired remote controller	Communication between wired remote controller and indoor unit is not possible.
06*	Problem in Refrigerant pipe sensor (Outlet side)	Refrigerant outlet pipe temperature sensor of indoor unit is open or short.
08***	Problem in Water Tank sensor	Domestic hot water tank temperature sensor of indoor unit is open or short.
09****	PCB Program (EEPROM) Fault	The optional EEPROM is loosely inserted in or disconnected from the Main PCB(Indoor)
13***	Problem in Solar-thermal sensor	Solar pipe temperature sensor of indoor unit is open or short.
15****	Overheating of water pipe	The temperature of the water pipe has exceeded a certain temperature.
16****	Problems in sensors	An error code 17,18,19 error has occurred at the same time.
17*	Problem in Water-inlet sensor	Water inlet pipe temperature sensor of indoor unit is open or short.
18*	Problem in Water-outlet sensor	Water outlet pipe temperature sensor of indoor unit is open or short.
19*	Problem in Elec/Heater Water-outlet sensor	Electric backup heater outlet temperature sensor of indoor unit is open or short.
20****	Electric heater overheated	Fuse of electric heater is blown due to overheat.

- Notice of error code

- Slight Trouble : \*
- Heavy Trouble : \*\*
- Other Trouble(O-Trouble) : \*\*\*
- Critical Trouble / Error : \*\*\*\*

# MAINTENANCE AND SERVICE

## Maintenance activities

In order to ensure optimal availability of the unit, a number of checks and inspections on the unit and the field wiring have to be carried out at regular intervals, preferably yearly. This maintenance should be carried out by your local agreed technician.

---

### **WARNING**

- Always check for gas (refrigerant) leakage before starting work of unit by using the gas sniffer (Gas sniffer must be suitable for R290).
  - If a leak occurs, close all covers of the product, notify the end user and customer service.
  - Be sure to check there are no continuously operating open flames (for example an operating gas appliance) and ignition sources (for example an operating electric heater) near the product.
  - Be sure to check the product shall be stored in a well-ventilated area.
  - Use restrictions unauthorized people entering safety zone.
    - Make sure the water pressure is not too high or too low.
    - Check if water is leaking from the water pipe.
    - Check whether the outdoor unit heat exchanger is blocked by dust or snow.
    - Check if snow is blocking the front or bottom of the product.
    - Check if the condensate is properly discharged from the outdoor unit.
    - Check if the outdoor unit defrost is working properly.
- 

## When the unit is not going....

---

### **CAUTION**

- If the product is not used for long time, we strongly recommend not to switch off the power supply to the product.
  - If the unit is not used and switch off the power supply to the unit for long time, we strongly recommend to drain off all water in the unit by certificated person.
  - When the power is applied for the first time, operate the product after preheating for 2 hours. To protect the unit by increasing the oil temperature of the compressor.
  - If power is not supplied, some special product-protecting actions (such as water pump anti-locking) will not performed.
-

---

## Call the service immediately in the following situations

- Anything abnormal such as burning smell, loud noise etc. happen. Stop the unit and turn the breaker off. Never try to repair by yourself or restart the system in such cases.
- Main power cord is too hot or damaged.
- Error code is generated by self diagnosis.
- Water leaks from unit.
- Any switch, breaker (safety, earth) or fuse fails to work properly.
- User must carry routine checkup & cleaning to avoid unit's poor performance.
- In case of special situation, the job must be carried out by the only service person.

---

### CAUTION

- If the heating water contains antifreeze agent (glycole), do not drain the fluid into a sink, but collect it in a suitable container.
  - Do not touch the water if it contains antifreeze agent.
  - If the product has a leakage, do not operate the unit and contact dealer, seller or an authorized service center.
-

